

LAMBDA
DYNAMIC

LAMBDA
DYNAMIC

Lambda Dynamic Co.,Ltd
27/57 Soi Athon Upratham, Phacharath Sai 1 Road ,
Bangsue , Bangkok 10800

TEL : +6691-010-9191
Email : lambda.dynamic@gmail.com

INTERIOR LIGHTING CATALOGUE

2025-2026
INTERIOR LIGHTING CATALOGUE

LAMBDA DYNAMIC

Lambda Dynamic Co.,Ltd
27/57 Soi Athon Upratham, Phacharath Sai 1 Road ,
Bangsue , Bangkok 10800

TEL : +6691-010-9191
Emil : lambda.dynamic@gmail.com

INTERIOR LIGHTING CATALOGUE



RETROFIT DOWNLIGHT

Recessed Retrofit Round Downlight	8
Recessed Retrofit Square Downlight	16
Surface Retrofit Downlight	28
Recessed E27 Downlight	33
Surface E27 Downlight	41

BUILT-IN LED DOWNLIGHT

Recessed Built-In LED Round Downlight	46
Surface Built-In LED Round Downlight	62
Recessed Built-In LED Square Downlight	64
Linear Built-In LED Downlight	72
Surface Built-In LED Square Downlight	76

TRACK LIGHT SYSTEM

Track Spotlight	80
Track Accessories	90

INTERIOR WALL LIGHT

Interior LED Wall Light	92
LED Reading Light	97
LED Vanity Light	103

LED STRIPLIGHT

LED Striplight	109
Tunable White/ RGB LED Striplight	113
LED Accessories	116

FLUORESCENT LIGHT

Fluorescent Light	121
-------------------	-----

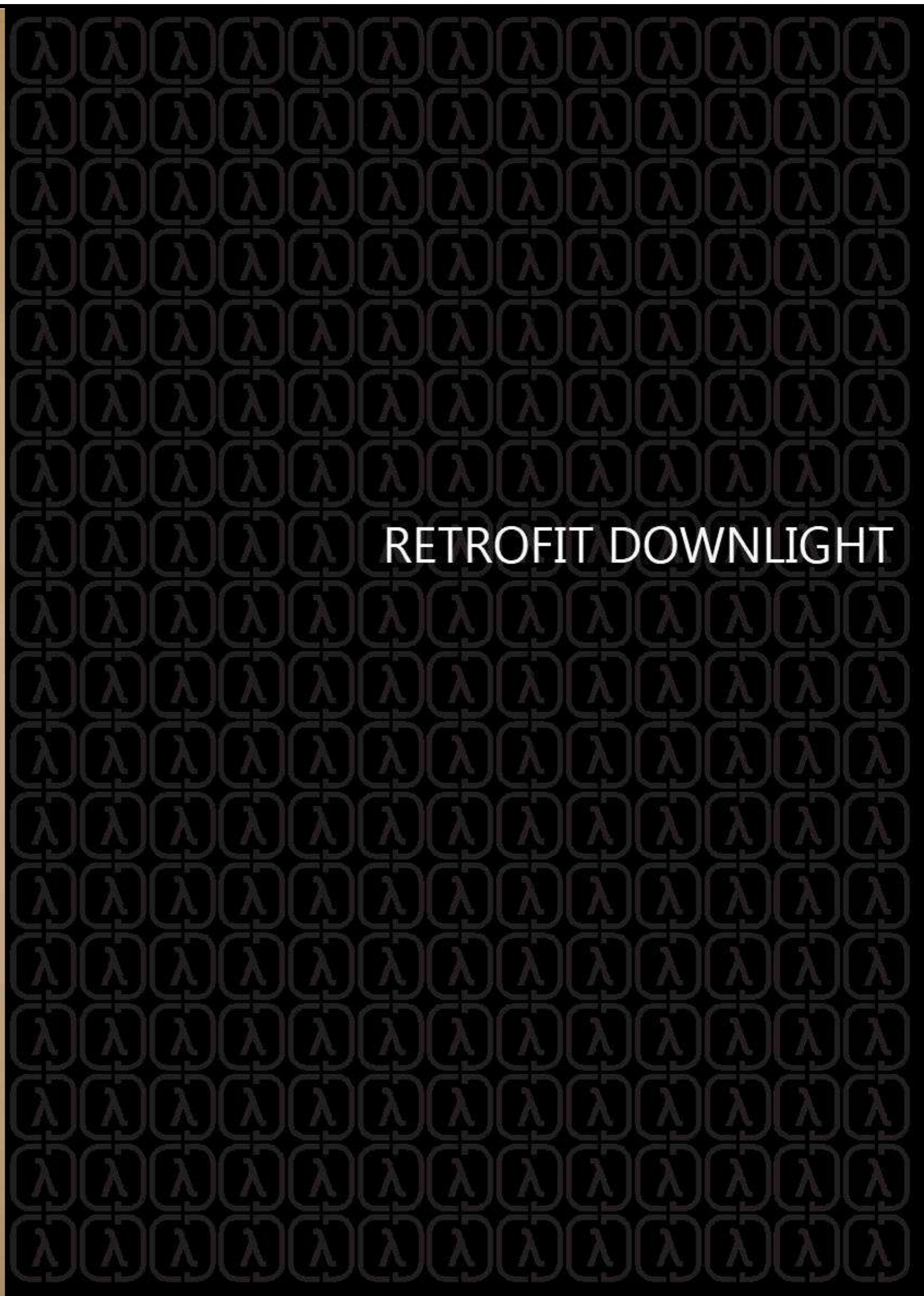
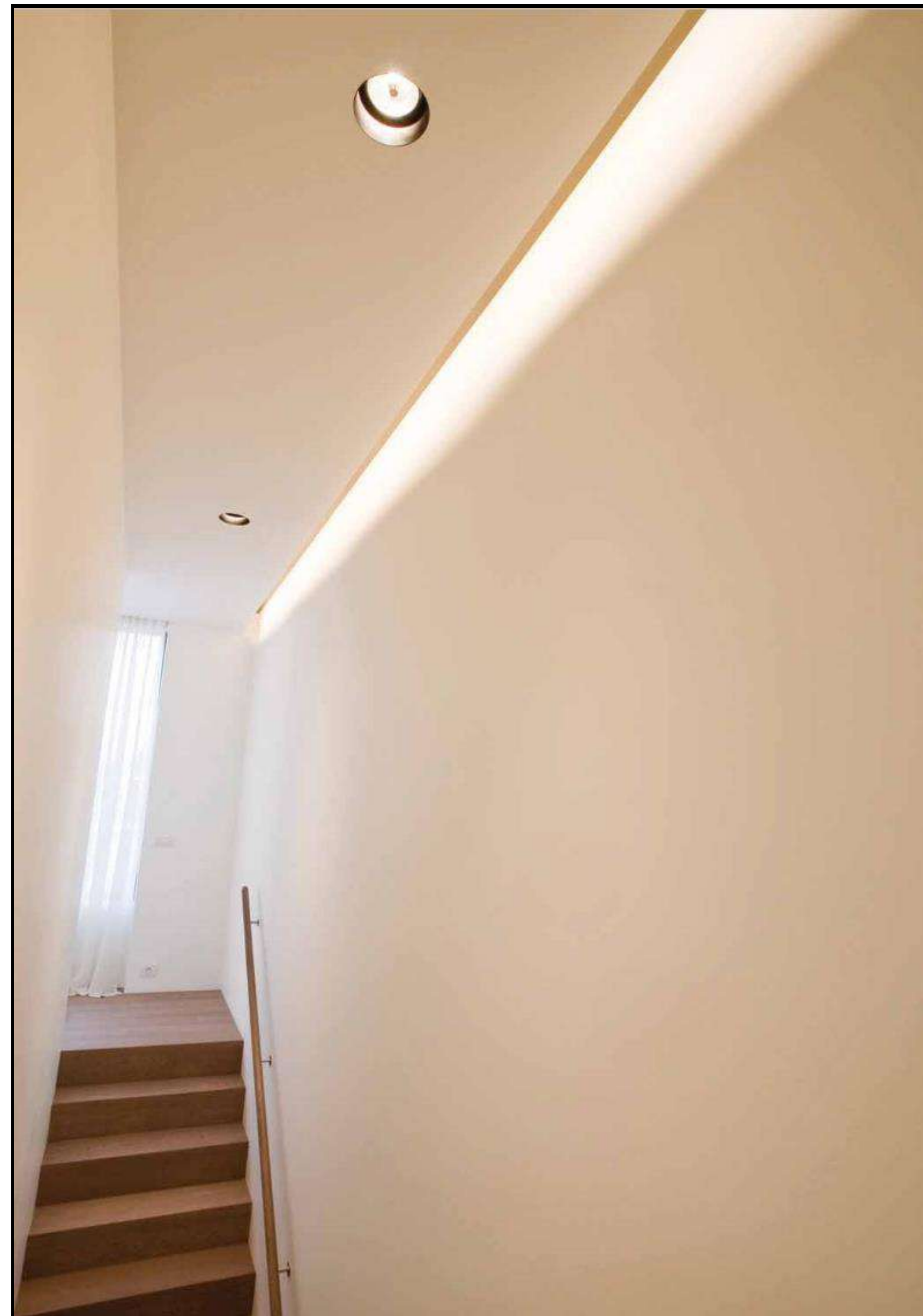



R-D-101/xx-MR16

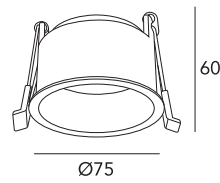

Description Recessed fixed mini downlight
 Lamp MR16 / PAR16
 Beam 15°, 24°, 36°, 60°
 Socket/Input Voltage GU5.3,12VDC / GU10,220V
 Size 75mm DIA. X 60mm(H)
 Cutout 69mm.



R-D-103/xx-MR16

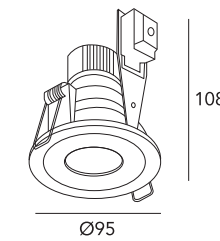

Description Recessed Fixed Pinhole downlight
 Lamp MR16 / PAR16
 Beam 15°, 24°, 36°, 60°
 Socket/Input Voltage GU5.3,12VDC / GU10,220V
 Size 95mm DIA. X 108mm(H)
 Cutout 83mm.
 Accessories Lens/Honeycomb



R-D-102/xx-MR16

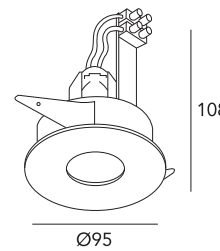

Description Recessed fixed pinhole downlight
 Lamp MR16 / PAR16
 Beam 15°, 24°, 36°, 60°
 Socket/Input Voltage GU5.3,12VDC / GU10,220V
 Size 95mm DIA. X 108mm(H)
 Cutout 83mm.
 Accessories Pre-mounted kit

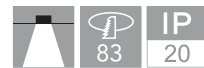

Pre-mounted Kit



A-D-102/xx-MR16

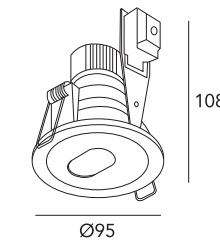

Description Recessed Adjustable pinhole downlight
 Lamp MR16 / PAR16
 Beam 15°, 24°, 36°, 60°
 Socket/Input Voltage GU5.3,12VDC / GU10,220V
 Size 95mm DIA. X 108mm(H)
 Cutout 83mm.
 Accessories Lens/Honeycomb

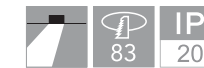

A-D-101/xx-MR16

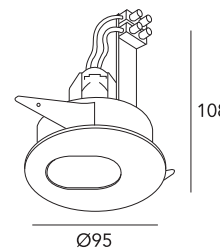

Description Recessed Adj. pinhole downlight
 Lamp MR16 / PAR16
 Beam 15°, 24°, 36°, 60°
 Socket/Input Voltage GU5.3,12VDC / GU10,220V
 Size 95mm DIA. X 108mm(H)
 Cutout 83mm.
 Accessories Pre-mounted kit

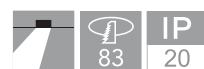

Pre-mounted Kit



A-D-103/xx-MR16

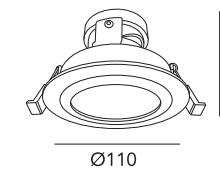

Description Recessed adjustable downlight
 Lamp MR16 / PAR16
 Beam 15°, 24°, 36°, 60°
 Socket/Input Voltage GU5.3,12VDC / GU10,220V
 Size 110mm DIA. X 70mm(H)
 Cutout 95mm.
 Accessories White reflector/ Lens/Honeycomb





A-D-104/xx-MR16

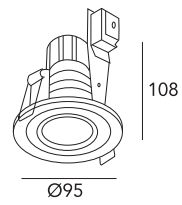

Description Recessed Adj. downlight with Black baffle

Lamp MR16 / PAR16

Beam 15°, 24°, 36°, 60°

Socket/Input Voltage GU5.3,12VDC / GU10,220V

Size 95mm DIA. X 108mm(H)

Cutout 83mm.

Accessories Lens/Honeycomb



A-D-106/xx-MR16

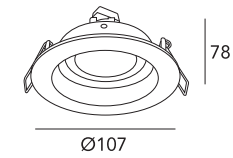

Description Recessed adj. downlight

Lamp MR16 / PAR16

Beam 15°, 24°, 36°, 60°

Socket/Input Voltage GU5.3,12VDC / GU10,220V

Size 107mm DIA. X 78mm(H)

Cutout 100mm.

Accessories Lens/ Honeycomb



R-D-104/xx-MR16

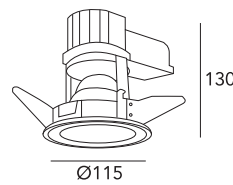

Description Recessed Fixed downlight with Reflector option

Lamp MR16 / PAR16

Beam 15°, 24°, 36°, 60°

Socket/Input Voltage GU5.3,12VDC / GU10,220V

Size 115mm DIA. X 130mm(H)

Cutout 98mm.

Accessories Lens/ Honeycomb

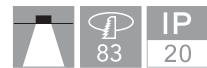

A-D-107/xx-MR16

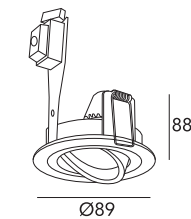

Description Recessed Fully Adj. mini downlight

Lamp MR16 / PAR16

Beam 15°, 24°, 36°, 60°

Socket/Input Voltage GU5.3,12VDC / GU10,220V

Size 95mm DIA. X 88mm(H)

Cutout 81mm.

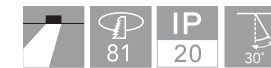

A-D-105/xx-MR16

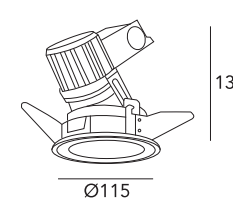

Description Recessed adj. downlight with reflector option

Lamp MR16 / PAR16

Beam 15°, 24°, 36°, 60°

Socket/Input Voltage GU5.3,12VDC / GU10,220V

Size 115mm DIA. X 130mm(H)

Cutout 98mm.

Accessories Lens/ Honeycomb



A-D-109/xx-MR16

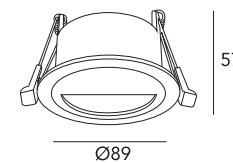

Description Recessed Wall washer downlight

Lamp MR16 / PAR16

Beam 15°, 24°, 36°, 60°

Socket/Input Voltage GU5.3,12VDC / GU10,220V

Size 89mm DIA. X 57mm(H)

Cutout 81mm.

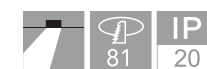



A-D-110/xx-MR16

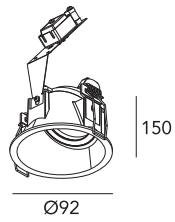

Description Recessed Wall washer downlight
Lamp MR16 / PAR16
Beam 15°, 24°, 36°, 60°
Socket/Input Voltage GU5.3,12VDC / GU10,220V
Size 92mm DIA. X 150mm(H)
Cutout 83mm.

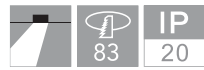

R-D-105/xx-MR16

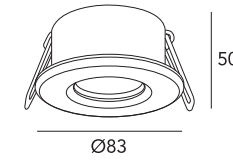

Description Recessed round pinhole downlight with lens
Lamp MR16 / PAR16
Beam 15°, 24°, 36°, 60°
Socket/ Input Voltage GU5.3,12VDC / GU10,220V
Size 83mm DIA. X 50mm(H)
Ceiling cut out 70mm DIA.
Accessories Include frosted lens



R-D-111/xx-MR16

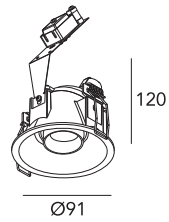

Description Recessed Fully Adj. with snout downlight
Lamp MR16/ PAR16
Beam 15°, 24°, 36°, 60°
Socket/Input Voltage GU5.3,12VDC / GU10,220V
Size 86mm DIA. X 120mm(H)
Cutout 83mm.
Accessories Lens/ Honeycomb

Color Optional



R-D-106/xx-MR16

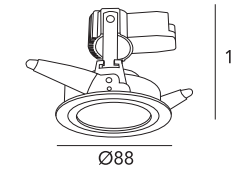

Description Recessed round downlight with lens
Lamp MR16 / PAR16
Beam 15°, 24°, 36°, 60°
Socket/ Input Voltage GU5.3,12VDC / GU10,220V
Size 88mm DIA. X 105mm(H)
Ceiling cut out 78mm DIA.
Accessories Include frosted lens



R-D-107/xx-MR16

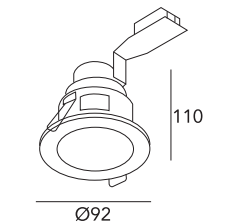

Description Recessed round downlight with lens
Lamp MR16 / PAR16
Beam 15°, 24°, 36°, 60°
Socket/ Input Voltage GU5.3,12VDC / GU10,220V
Size 92mm DIA. X 88mm(H)
Ceiling cut out 76mm DIA.
Accessories Include frosted lens





A-D-112/xx-AR111

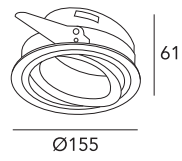

Description Recessed Fully Adj. downlight with black baffle

Lamp AR111

Beam 15°, 25°, 40°

Socket/Input Voltage G53/12V

Size 155mm DIA. X 61mm(H)

Cutout 142mm.



R-D-108/xx-PAR30

R-D-108/xx-AR111

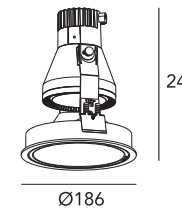

Description Recessed Fixed downlight with reflector

Lamp AR111 / PAR30

Beam 15°, 25°, 40°

Socket/Input Voltage G53, 12V / E27, 220V

Size 186mm DIA. X 245mm(H)

Cutout 178mm.



A-D-113/xx-PAR30

A-D-113/xx-AR111

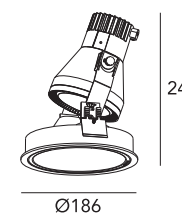

Description Recessed Adj. downlight with reflector

Lamp AR111 / PAR30

Beam 15°, 25°, 40°

Socket/Input Voltage G53, 12V / E27, 220V

Size 186mm DIA. X 245mm(H)

Cutout 178mm.





R-SQ-101/xx-MR16

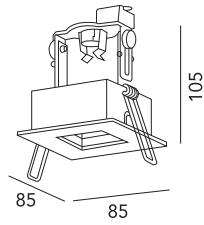

Description Recessed fixed square pinhole downlight
Lamp MR16 / PAR16
Beam 15°, 24°, 36°, 60°
Socket/Input Voltage GU5.3,12VDC/ GU10,220V
Size 85mm sq. X 105mm(H)
Cutout 73mm. sq
Accessories Lens / Honeycomb



R-SQ-103/xx-MR16

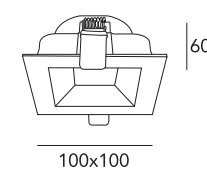

Description Recessed fixed pinhole square downlight with reflector
Lamp MR16 / PAR16
Beam 15°, 24°, 36°, 60°
Socket/Input Voltage GU5.3,12VDC/ GU10,220V
Size 100mm sq X 60mm(H)
Cutout 90mm. sq

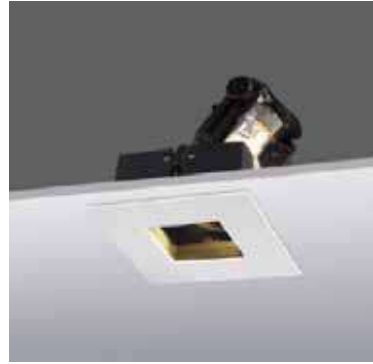

A-SQ-101/xx-MR16

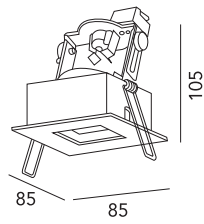

Description Recessed fully adj. square pinhole downlight
Lamp MR16 / PAR16
Beam 15°, 24°, 36°, 60°
Socket/Input Voltage GU5.3,12VDC/ GU10,220V
Size 85mm sq. X 105mm(H)
Cutout 73mm. sq
Accessories Lens / Honeycomb



A-SQ-102/xx-MR16

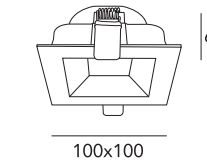

Description Recessed Adj. pinhole square downlight with reflector
Lamp MR16 / PAR16
Beam 15°, 24°, 36°, 60°
Socket/Input Voltage GU5.3,12VDC/ GU10,220V
Size 100mm sq X 60mm(H)
Cutout 90mm. sq



R-SQ-102/xx-MR16

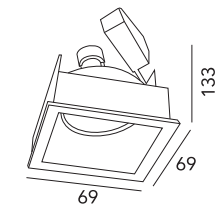

Description Recessed fixed square downlight
Lamp MR16 / PAR16
Beam 15°, 24°, 36°, 60°
Socket/Input Voltage GU5.3,12VDC/ GU10,220V
Size 69mm sq. X 133mm(H)
Cutout 62mm. sq
Accessories Lens/snoot/ bavel



R-SQ-104/xx-MR16

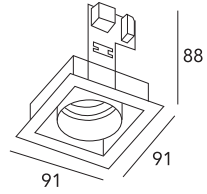

Description Recessed fixed square downlight with snoot
Lamp MR16 / PAR16
Beam 15°, 24°, 36°, 60°
Socket/Input Voltage GU5.3,12VDC/ GU10,220V
Size 91mm sq. X 88mm(H)
Cutout 78mm.





A-SQ-103/xx-MR16

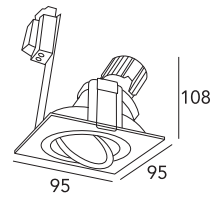

Description Recessed Adj. Square downlight with black baffle

Lamp MR16 / PAR16

Beam /Color 15°, 24°, 36°, 60°

Socket/ Input Voltage GU5.3,12VDC / GU10,220V

Size 95mm Sq. X 108mm(H)

Ceiling cut out 62mm Sq.



A-SQ-105/xx-MR16

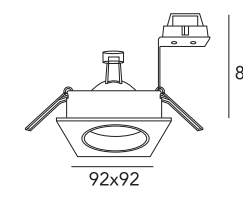

Description Recessed Square downlight

Lamp MR16/ PAR16

Beam /Color 15°, 24°, 36°, 60°

Socket/ Input Voltage GU5.3,12VDC / GU10,220V

Size 92mm DIA X 85mm(H)

Ceiling cut out 79mm sq.



A-SQ-104/xx-MR16

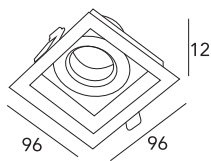

Description Recessed Fully Adj. Square downlight

Lamp MR16 / PAR16

Beam /Color 15°, 24°, 36°, 60°

Socket/ Input Voltage GU5.3,12VDC / GU10,220V

Size 96mm Sq. X 125mm(H)

Ceiling cut out 83mm Sq.



Black Reflector Optional



A-SQ-105/xx-2xMR16

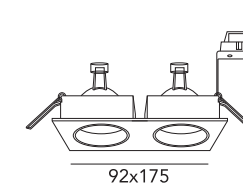

Description Recessed Adj. Rectangular downlight

Lamp MR16/ PAR16

Beam /Color 15°, 24°, 36°, 60°

Socket/ Input Voltage GU5.3 / 12V DC, GU10/ 220V

Size 92mm(W) X 175mm(L) X 96mm(H)

Ceiling cut out 80mm X 160mm



A-SQ-104/xx-2xMR16

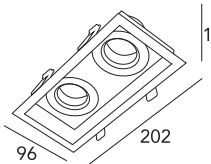

Description Recessed Fully Adj. Rectangular downlight

Lamp (2)MR16 / (2)PAR16

Beam 15°, 24°, 36°, 60°

Socket/Input Voltage GU5.3,12VDC / GU10,220V

Size 96mm (W) X 202mm(L) X 125mm(H)

Cutout 83mm X 190mm



Black Reflector Optional



R-SQ-105/xx-MR16

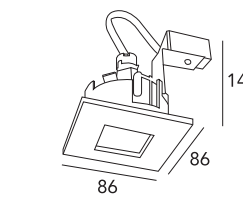

Description Recessed square pinhole downlight with lens

Lamp MR16/ PAR16

Beam 15°, 24°, 36°, 60°

Socket/Input Voltage GU5.3 / 12V DC, GU10/ 220V

Size 86mm sq X 140mm(H)

Cutout 70mm. sq

Accessories Include Frsoted lens





R-SQ-106/xx-MR16

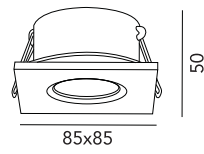

Description Recessed square pinhole downlight with lens
Lamp MR16/ PAR16
Socket/ Input Voltage GU5.3,12V DC / GU10,220V
Beam /Color 15°, 24°, 36°, 60°
Size 85mm sq X 50mm(H)
Ceiling cut out 78mm X 78mm
Accessories Include Frosted lens



A-SQ-107/xx-MR16

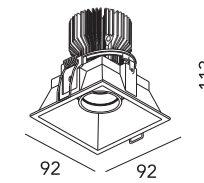

Description Recessed Adj. square downlight with snout
Lamp MR16/ PAR16
Beam /Color 15°, 24°, 36°, 60°
Socket/ Input Voltage GU5.3,12V DC / GU10,220V
Size 92mmsq X 113mm(H)
Ceiling cut out 83mm X 83mm

Color Optional



R-SQ-105/xx-MR16

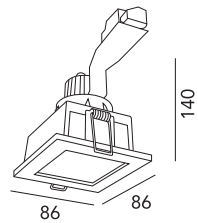

Description Recessed square downlight with lens
Lamp MR16/ PAR16
Beam 15°, 24°, 36°, 60°
Socket/Input Voltage GU5.3,12V DC / GU10,220V
Size 86mm sq. X 140mm(H)
Cutout 76mm.
Accessories Include Frosted lens



A-SQ-106/xx-MR16

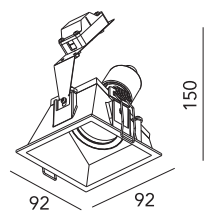

Description Recessed Square wall washer downlight
Lamp MR16/ PAR16
Beam /Color 15°, 24°, 36°, 60°
Socket/ Input Voltage GU5.3 / 12V DC, GU10/220V
Size 92mm sq X 150mm(H)
Ceiling cut out 83mm X 83mm

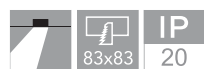

A-SQ-107/xx-2xMR16

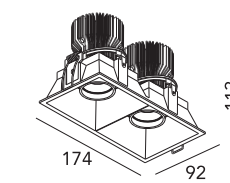

Description Recessed Adj. Rectangular downlight with snout
Lamp (2)MR16/ 2)PAR16
Beam /Color 15°, 24°, 36°, 60°
Socket/ Input Voltage GU5.3,12V DC / GU10,220V
Size 92mm(W) X 174mm(L) X 113mm(H)
Ceiling cut out 86mm x 168mm
Accessories Lens / Honeycomb
Color Refer to Square Version



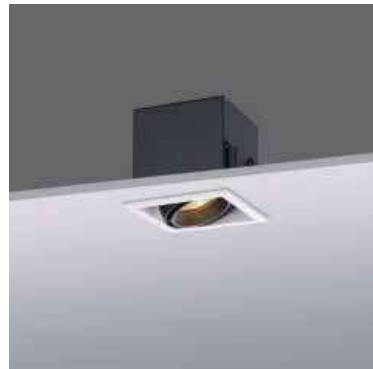

A-SQ-108/xx-MR16

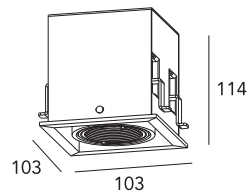

Description Recessed Fully Adj. Square downlight
Lamp MR16/ PAR16
Beam 15°, 24°, 36°, 60°
Socket/ Input Voltage GU5.3,12VDC/ GU10,220V
Size 103mm sq X 114mm(H)
Ceiling cut out 93mm X 93mm



Snoot Optional

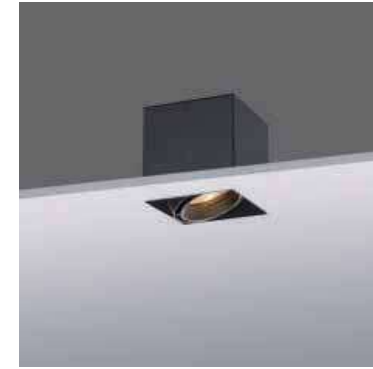

A-SQ-109/xx-MR16

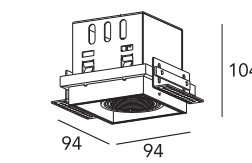

Description Recessed Fully Adj. Trimless square downlight
Lamp MR16/ PAR16
Beam 15°, 24°, 36°, 60°
Socket/ Input Voltage GU5.3,12VDC/ GU10,220V
Size 94mm sq X 104mm(H)
Ceiling cut out 95mm X 95mm



Snoot Optional



A-SQ-108/xx-2xMR16

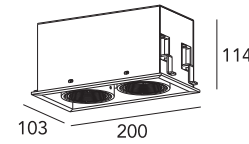

Description Recessed Fully Adj. Rectangular downlight
Lamp (2)MR16/ (2)PAR16
Beam 15°, 24°, 36°, 60°
Socket/ Input Voltage GU5.3,12VDC/ GU10,220V
Size 103mm(W) X 200mm(L) X 114mm(H)
Ceiling cut out 93mm X 190mm



Snoot Optional



A-SQ-109/xx-2xMR16

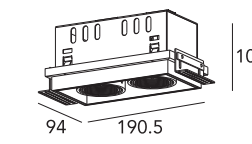

Description Recessed Fully Adj. trimless Rectangular downlight
Lamp (2)MR16/ (2)PAR16
Beam 15°, 24°, 36°, 60°
Socket/ Input Voltage GU5.3,12VDC/ GU10,220V
Size 94mm(W) X 190.5mm(L) X 104mm(H)
Ceiling cut out 95mm X 191mm



Snoot Optional



A-SQ-108/xx-3xMR16

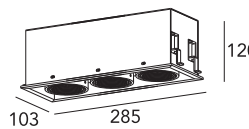

Description Recessed Fully Adj. Rectangular downlight
Lamp (3)MR16/ (3)PAR16
Beam 15°, 24°, 36°, 60°
Socket/ Input Voltage GU5.3,12VDC/ GU10,220V
Size 103mm (W) X 285mm(L) X 120mm(H)
Ceiling cut out 93mm X 275mm



Snoot Optional



A-SQ-102/xx-3xMR16

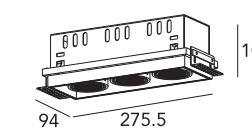

Description Recessed Fully Adj. trimless Rectangular downlight
Lamp (3)MR16/ (3)PAR16
Beam 15°, 24°, 36°, 60°
Socket/ Input Voltage GU5.3,12VDC/ GU10,220V
Size 94mm(W) X 275.5mm(L) X 104mm(H)
Ceiling cut out 95mm X 276mm



Snoot Optional





A-SQ-110/xx-AR111

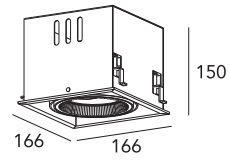

Description Recessed Fully Adj. square downlight AR111

Lamp AR111

Beam 15°, 24°, 40°

Socket/ Input Voltage G53,12VDC

Size 166mm sq X 150mm(H)

Ceiling cut out 156mm sq



A-D-108/xx-AR111

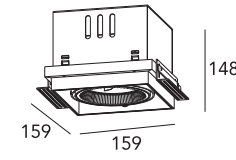

Description Recessed Fully Adj. trimless square downlight AR111

Lamp AR111

Beam 15°, 24°, 40°

Socket/ Input Voltage G53,12VDC

Size 159mm sq X 148mm(H)

Ceiling cut out 160mm sq



A-SQ-110/xx-2xAR111

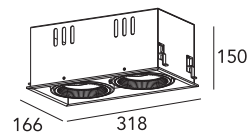

Description Recessed Fully Adj. Rectangular downlight (2)AR111

Lamp (2)AR111

Beam 15°, 24°, 40°

Socket/ Input Voltage G53,12VDC

Size 166mm(W) X 318(L) X 150mm(H)

Ceiling cut out 156mm X 308mm



A-SQ-111/xx-2xAR111

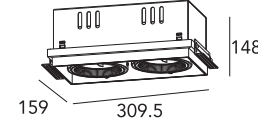

Description Recessed Fully Adj. trimless rectangular downlight (2)AR111

Lamp (2)AR111

Beam 15°, 24°, 40°

Socket/ Input Voltage G53,12VDC

Size 159mm(W) X 305.5(L) X 148mm(H)

Ceiling cut out 160mm X 306mm



R-SQ-108/xx-3xAR111

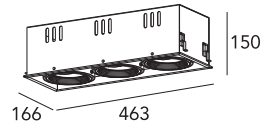

Description Recessed Fully Adj. Rectangular downlight (3)AR111

Lamp (3)AR111

Beam 15°, 24°, 40°

Socket/ Input Voltage G53,12VDC

Size 166mm(W) X 463(L) X 150mm(H)

Ceiling cut out 156mm X 453mm



A-SQ-111/xx-3xAR111

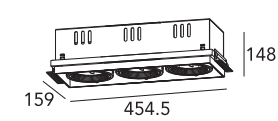

Description Recessed Fully Adj. trimless rectangular downlight (3)AR111

Lamp (3)AR111

Beam 15°, 24°, 40°

Socket/ Input Voltage G53,12VDC

Size 159mm(W) X 454.5(L) X 148mm(H)

Ceiling cut out 160mm X 455mm





R-SQ-108/xx-AR111

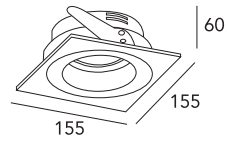

Description Recessed Fixed downlight
 Lamp AR111
 Beam 15°, 25°, 40°
 Socket/Input Voltage G53, 12VDC
 Size 155mm SQ. X 60mm(H)
 Cutout 142mm. (DIA)



A-SQD-112/xx-AR111

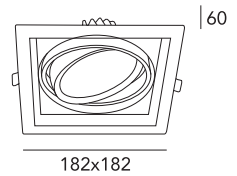

Description Recessed Fully Adj square downlight
 Lamp AR111
 Beam 15°, 25°, 40°
 Socket/Input Voltage GU53, 12VDC
 Size 182mm sq X 60mm(H)
 Cutout 150mm. sq



A-SQ-112/xx-2xAR111

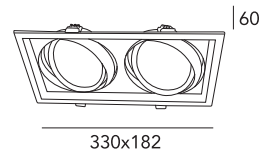

Description Recessed Fully Adj. Rectangular downlight
 Lamp AR111
 Beam 15°, 25°, 40°
 Socket/Input Voltage G53, 12VDC
 Size 182mm(W) X 330mm(L) X 60mm(H)
 Cutout 150mm X 300mm





S-D-101/xx-MR16

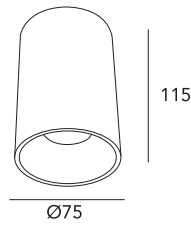

Description Surface mount round fixed downlight

Lamp MR16/ PAR16

Beam 15°, 24°, 36°, 60°

Socket/Input Voltage GU5.3,12VDC/ GU10,220V

Size 75mm DIA. X 115mm(H)



S-D-102/xx-MR16

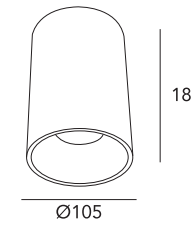

Description Surface mount round downlight with lens

Lamp MR16/ PAR16

Beam 15°, 24°, 36°, 60°

Socket/Input Voltage GU5.3,12VDC/ GU10,220V

Size 105mm DIA. X 180mm(H)



S-A-R-101/xx-MR16

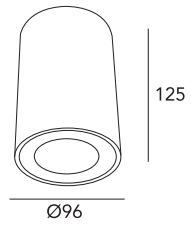

Description Surface mount round adj. downlight

Lamp MR16/ PAR16

Beam 15°, 24°, 36°, 60°

Socket/Input Voltage GU5.3,12VDC/ GU10,220V

Size 96mm DIA. X 125mm(H)



S-A-SQ-101/xx-MR16

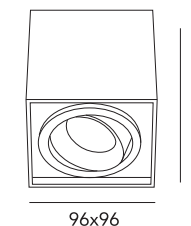

Description Surface mount Fully Adj. square downlight

Lamp MR16/ PAR16

Beam 15°, 24°, 36°, 60°

Socket/ Input Voltage GU5.3,12VDC/ GU10,220V

Size 96mm sq X 100mm(H)



S-D-103/xx-AR111

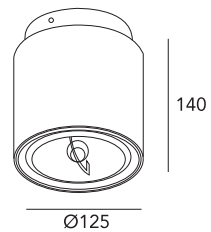

Description Surface mount round fixed downlight

Lamp AR111

Beam 15°, 25°, 40°

Socket/Input Voltage G53,12VDC

Size 125mm DIA. X 140mm(H)

Note Remote LED driver



S-A-SQ-101/xx-2xMR16

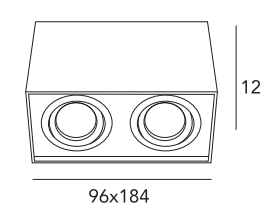

Description Surface mount Fully Adj. rectangular downlight

Lamp (2)MR16/ (2)PAR16

Beam 15°, 24°, 36°, 60°

Socket/ Input Voltage GU5.3,12VDC/ GU10,220V

Size 96mm(W) X 184(L) X 125mm(H)





S-A-SQ-102/xx-MR16

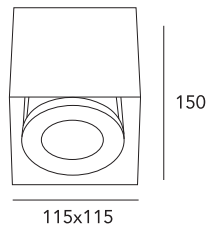

Description Surface mount Fully Adj. square downlight
Lamp MR16/ PAR16
Beam 15°, 24°, 36°, 60°
Socket/ Input Voltage GU5.3,12VDC/ GU10,220V
Size 115mm sq X 150mm(H)



S-A-SQ-103/xx-AR111

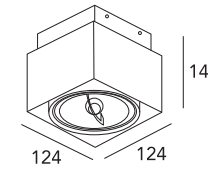

Description Surface mount Fully Adjustable Single head downlight
Lamp AR111
Beam 15°, 25°, 40°
Socket/ Input Voltage G53,12V DC
Size 124mm Sq. X 140mm(H)



S-A-SQ-102/xx-2xMR16

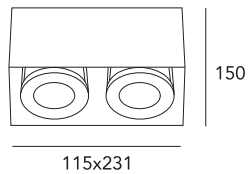

Description Surface mount Fully Adj. Rectangular downlight
Lamp (2)MR16/ (2)PAR16
Beam 15°, 24°, 36°, 60°
Socket/Input Voltage GU5.3,12VDC/ GU10,220V
Size 115mm (W) X 231mm(L) X 150mm(H)



S-A-SQ-103/xx-2xAR111

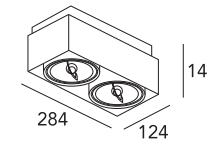

Description Surface mount Fully Adjustable double head downlight
Lamp (2)AR111
Beam 15°, 25°, 40°
Socket/Input Voltage G53,12VDC
Size 124mm(W) x 284mm (L) X 140mm(H)



S-SQ-101/xx-MR16

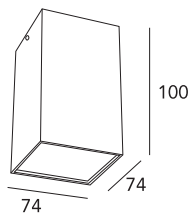

Description Surface mount square downlight with lens
Lamp MR16/ PAR16
Beam 15°, 24°, 36°, 60°
Socket/ Input Voltage GU5.3, 12VDC/ GU10,220V
Size 74mm sq X 100mm(H)
Noted Come with frosted glass lens



S-A-SQ-103/xx-3xAR111

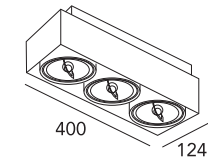

Description Surface mount Fully Adjustable triple head downlight
Lamp (3)AR111
Beam 15°, 25°, 40°
Socket/Input Voltage G53, 12VDC
Size 124mm(W) x 400mm (L) X 140mm(H)





R-D-001/xx-E27

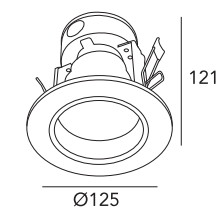

Description Recessed E27 downlight vertical lamp
Lamp CFL/ LED Bulb
Socket/ Input Voltage E27,220VAC
Size 125mm DIA X 121mm(H)
Ceiling cut out 78mm DIA
Accessories Sand Silver Reflector
 Mirror Aluminum Reflector



R-D-002/xx-E27

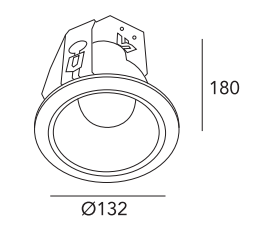

Description Recessed E27 downlight vertical lamp
Lamp CFL/ LED Bulb/ PAR30
Socket/ Input Voltage E27,220VAC
Size 132mm DIA X 180mm(H)
Ceiling cut out 115mm DIA
Accessories Sand Silver Reflector
 Mirror Aluminum Reflector



R-D-003/xx-E27

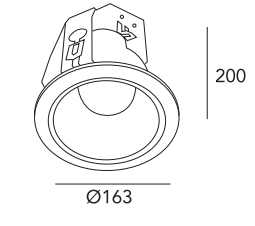

Description Recessed E27 downlight vertical lamp
Lamp CFL/ LED Bulb/ PAR30
Socket/ Input Voltage E27,220VAC
Size 163mm DIA X 200mm(H)
Ceiling cut out 145mm DIA
Accessories Sand Silver Reflector
 Mirror Aluminum Reflector





R-D-004/xx-E27

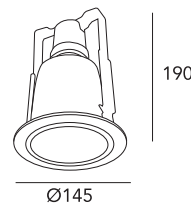

Description Recessed E27 downlight vertical lamp
Lamp CFL,LED Bulb
Socket/ Input Voltage E27 / 220VAC
Size 145mm DIA. X 190mm(H)
Ceiling cut out 125mm DIA.



R-D-007/xx-E27

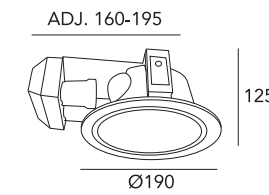

Description Recessed E27 downlight horizontal lamp
Lamp (2)CFL, (2)LED Bulb
Socket/ Input Voltage E27 / 220VAC
Size 190mm DIA. X 125mm(H)
Ceiling cut out 175mm DIA.
Accessories Sand Silver Reflector
 Mirror Aluminum Reflector



R-D-005/xx-E27

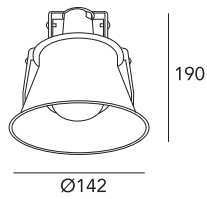

Description Recessed E27 downlight vertical lamp
Lamp CFL,LED Bulb
Socket/ Input Voltage E27 / 220VAC
Size 142mm DIA. X 190mm(H)
Ceiling cut out 123mm DIA.

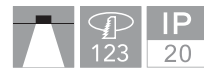

R-D-008/xx-E27

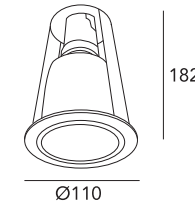

Description Recessed E27 glass cover downlight vertical lamp
Lamp CFL/ LED Bulb
Socket/ Input Voltage E27 / 220VAC
Size 110mm DIA X 182mm(H)
Ceiling cut out 100mm DIA
Noted Come with frosted glass cover



R-D-006/xx-E27

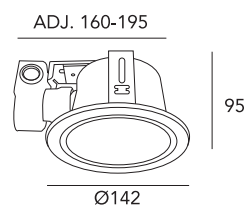

Description Recessed E27 downlight horizontal lamp
Lamp CFL,LED Bulb
Socket/ Input Voltage E27 / 220VAC
Size 142mm DIA. X 95mm(H)
Ceiling cut out 123mm DIA.
Accessories Sand Silver Reflector
 Mirror Aluminum Reflector

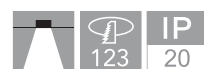

R-D-009/xx-E27

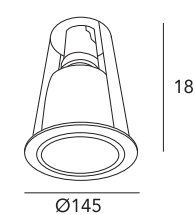

Description Recessed E27 glass cover downlight vertical lamp
Lamp CFL/ LED Bulb/ PAR30
Socket/ Input Voltage E27 / 220VAC
Size 145mm DIA X 185mm(H)
Ceiling cut out 105mm DIA
Noted Come with frosted glass cover





R-D-010/xx-E27

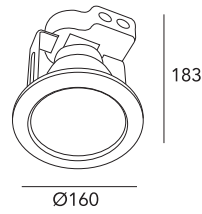

Description Recessed E27 glass cover downlight vertical lamp
Lamp CFL/ LED Bulb / PAR30
Socket/ Input Voltage E27 / 220VAC
Size 160mm DIA X 183mm(H)
Ceiling cut out 145mm DIA
Noted Come with frosted glass cover

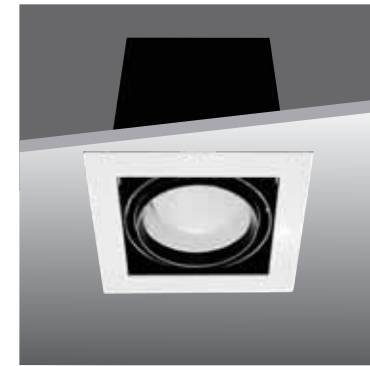

A-SQ-001/xx-E27

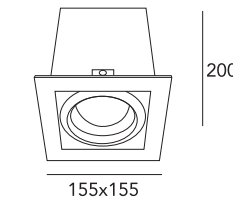

Description Recessed Fully Adjustable Square E27 downlight with reflector
Lamp CFL/ LED BULB/ PAR20
Socket/ Input Voltage E27/ 220V
Size 155mm Sq. X 200mm(H)
Ceiling cut out 140mm Sq.

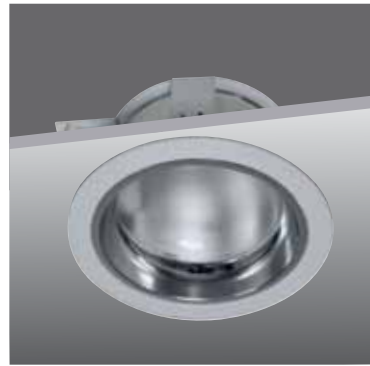

R-D-011/xx-E27

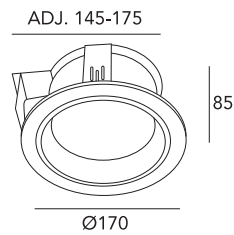

Description Recessed E27 glass cover downlight horizontal lamp
Lamp CFL,LED Bulb
Socket/ Input Voltage E27 / 220VAC
Size 170mm DIA. X 85mm(H)
Ceiling cut out 135mm DIA.
Noted Come with frosted glass cover

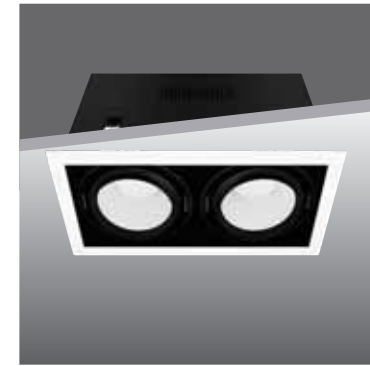

A-SQ-002/xx-2xE27

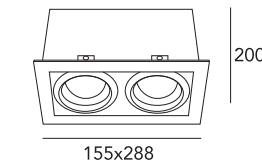

Description Recessed Fully Adjustable rectangular E27 downlight (2)CFL/ (2)LED Bulb / (2)PAR20
Lamp CFL/ LED Bulb / PAR20
Socket/ Input Voltage E27/ 220V
Size 155mm(W) X 258(L) X 200mm(H)
Ceiling cut out 140mm X 273mm



R-D-012/xx-E27

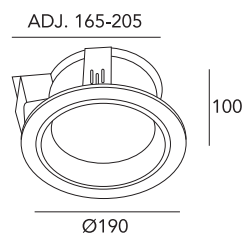

Description Recessed E27 glass cover downlight horizontal lamp
Lamp (2)CFL, (2)LED Bulb
Socket/ Input Voltage E27 / 220VAC
Size 190mm DIA. X 100mm(H)
Ceiling cut out 160mm DIA.
Noted Come with frosted glass cover

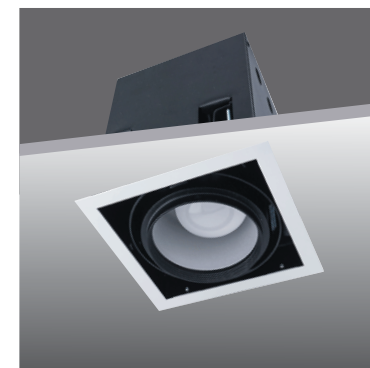
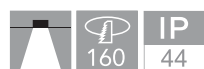

A-SQ-002/xx-E27

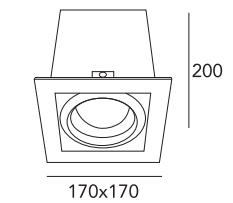

Description Recessed Fully Adjustable Square E27 downlight with reflector
Lamp CFL/ LED BULB/ PAR30
Socket/ Input Voltage E27/ 220V
Size 170mm Sq. X 200mm(H)
Ceiling cut out 158mm Sq.



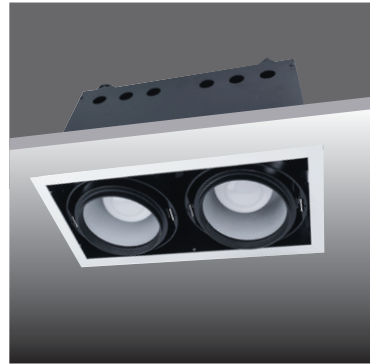

A-SQ-002/xx-E27

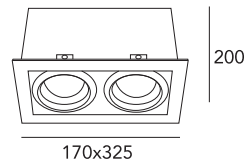

Description Recessed Fully Adjustable Square E27 downlight with reflector
Lamp (2)CFL/ (2)LED BULB/ (2)PAR30
Socket/ Input Voltage E27/ 220V
Size 170mm(W) X 325mm(L). X 200mm(H)
Ceiling cut out 158mm X 300mm



R-SQ-002/xx-E27

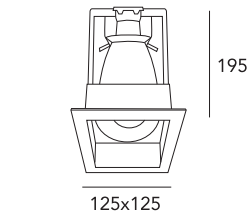

Description Recessed Square E27 downlight
Lamp CFL, LED BULB
Socket/ Input Voltage E27/ 220V
Size 125mm Sq. X 195mm(H)
Ceiling cut out 110mm Sq.



R-SQ-001/xx-E27

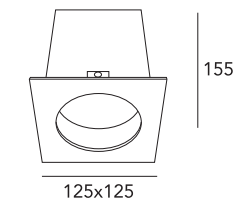

Description Recessed Single head Square E27 downlight
Lamp CFL, LED BULB
Socket/ Input Voltage E27/ 220V
Size 125mm Sq. X 155mm(H)
Ceiling cut out 110mm Sq.



R-SQ-003/xx-E27

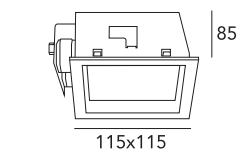

Description Recessed E27 glass cover square downlight (Horizontal lamp)
Lamp CFL,LED Bulb
Socket/ Input Voltage E27 / 220VAC
Size 115mm Sq. X 85mm(H)
Ceiling cut out 102mm Sq.
Note: Frosted glass lens



R-SQ-001/xx-2xE27

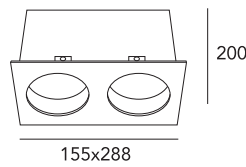

Description Recessed double head rectangular E27 downlight
Lamp CFL, LED BULB
Socket/ Input Voltage E27/ 220V
Size 155mm (W) X 288mm(L) X 200mm(H)
Ceiling cut out 110mm X 215mm



R-SQ-004/xx-E27

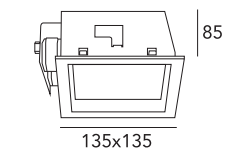

Description Recessed E27 glass cover square downlight (Horizontal lamp)
Lamp (2)CFL/ (2)LED Bulb
Socket/ Input Voltage E27 / 220VAC
Size 135mm Sq. X 85mm(H)
Ceiling cut out 122mm Sq.
Note: Frosted glass lens





S-D-001/xx-E27

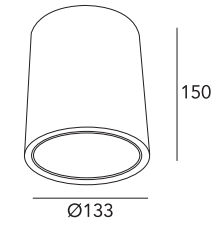

Description Surface mount E27 downlight vertical lamp
Lamp CFL/ LED Bulb/ PAR30
Socket/ Input Voltage E27/220VAC
Size 133mm DIA X 150mm(H)



S-D-002/xx-E27

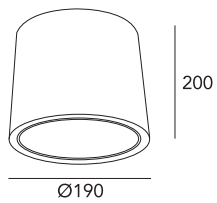

Description Surface mount E27 downlight vertical lamp
Lamp CFL/ LED Bulb/ PAR30
Socket/ Input Voltage E27/220VAC
Size 190mm DIA X 200mm(H)



S-D-003/xx-E27

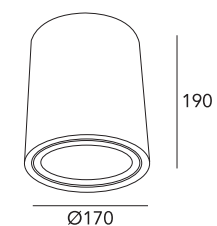

Description Surface mount round downlight with lens
Lamp CFL/ LED Bulb
Socket/Input Voltage E27/ 220V
Size 170mm DIA. X 190mm(H)
Noted Come with frosted glass cover





S-SQ-001/xx-E27

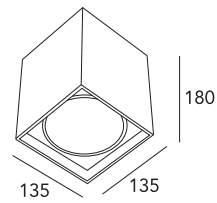

Description Surface mount E27 square downlight
 Lamp CFL/ LED Bulb/ PAR30
 Socket/Input Voltage E27/220V
 Size 135mm sq X 180mm(H)



S-A-SQ-001/xx-E27

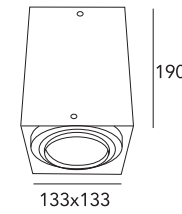

Description Surface mount Fully Adj. E27 square downlight
 Lamp CFL/ LED Bulb
 Socket/ Input Voltage E27/ 220V
 Size 133mm sq X 190mm(H)



S-SQ-002/xx-E27

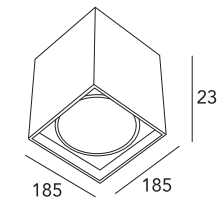

Description Surface mount E27 square downlight
 Lamp CFL/ LED Bulb/ PAR30
 Socket/Input Voltage E27/220V
 Size 185mm sq X 236 mm(H)



S-A-SQ-001/xx-2xE27

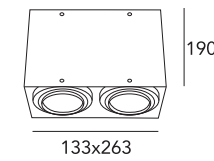

Description Surface mount Fully Adj. E27 rectangular downlight
 Lamp (2)CFL/ (2)LED Bulb
 Socket/ Input Voltage E27/ 220V
 Size 133mm (W) X 263mm(L) X 190mm(H)



S-SQ-003/xx-2xE27

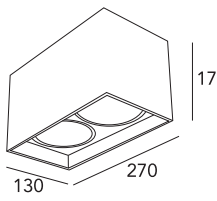

Description Surface mount E27 double head downlight
 Lamp (2)CFL/ (2)LED Bulb/ (2)PAR30
 Socket/Input Voltage E27/220V
 Size 130mm(W) X 270mm(L) X 170 mm(H)



S-A-SQ-002/xx-E27

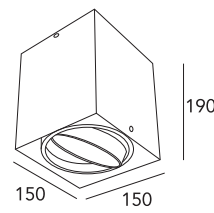

Description Surface mount Fully Adj. E27 square downlight
 Lamp CFL/ LED Bulb/ PAR30
 Socket/ Input Voltage E27/ 220V
 Size 150mm sq X 190mm(H)



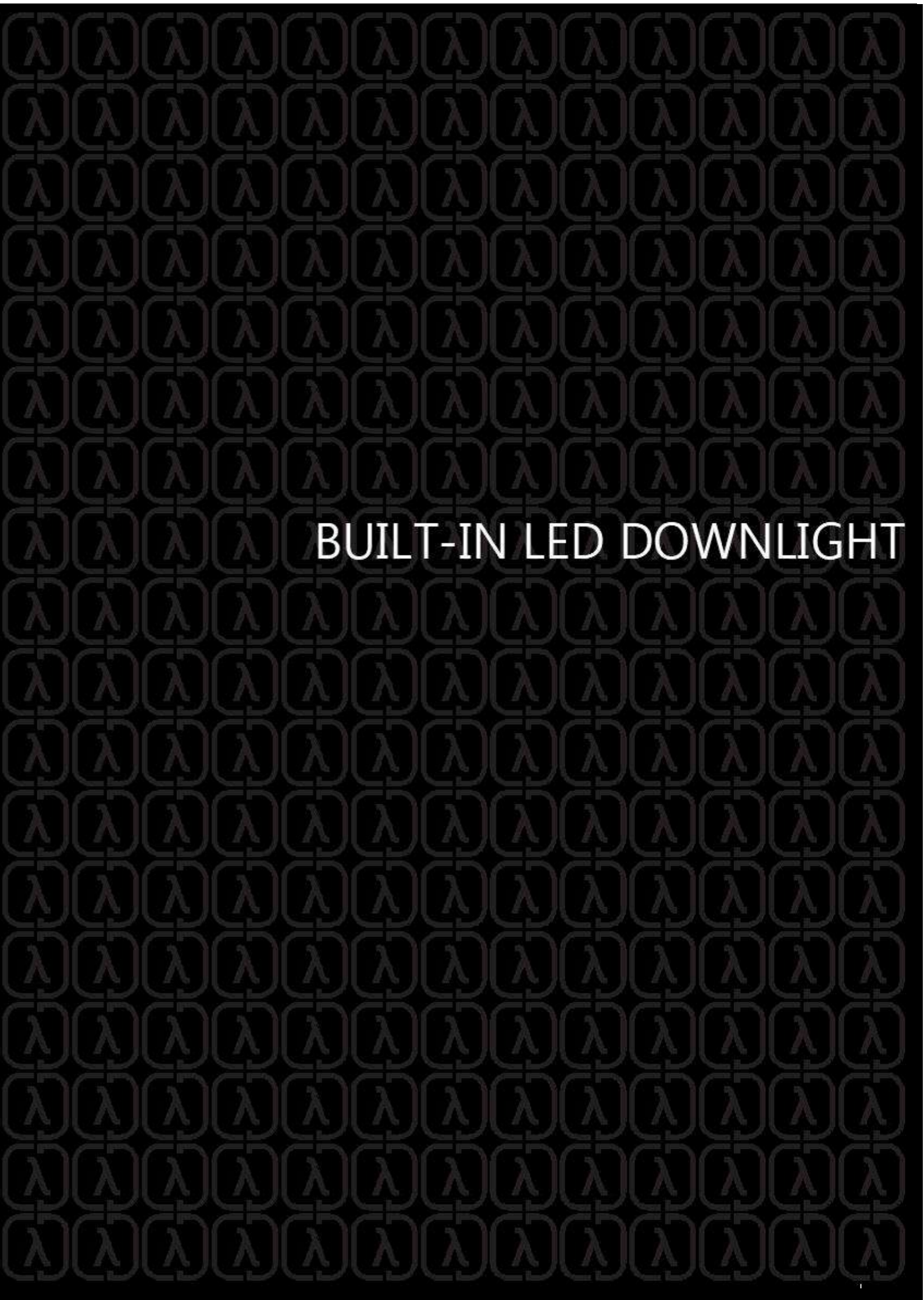
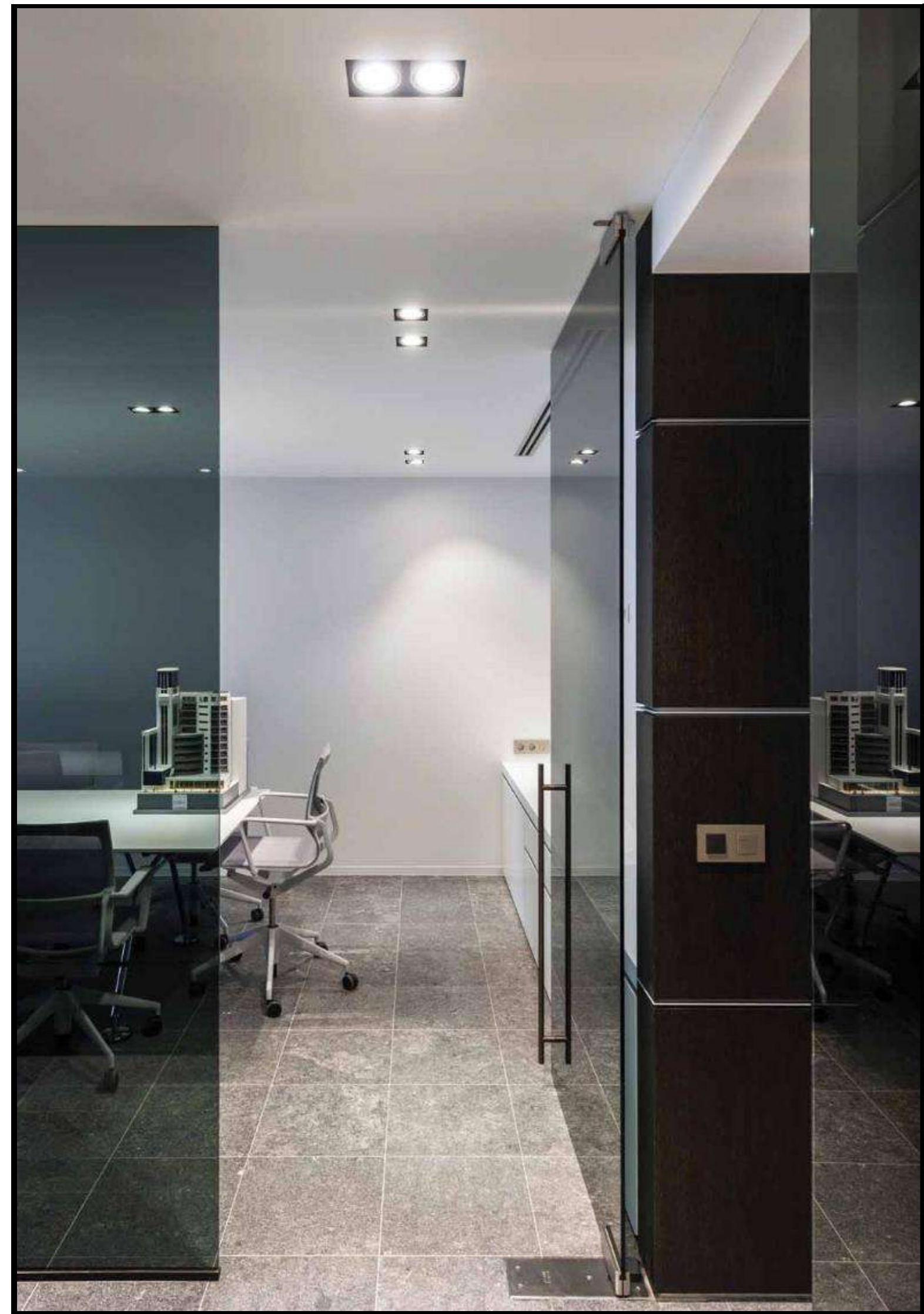

BUILT-IN LED DOWNLIGHT



R-D-201/xx-COB-1W-3K

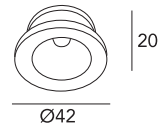

Description Recessed Mini LED downlight
Lamp COB LED 1W, 45lm
 COB LED 3W, 110lm
Beam 90°
Color 2700K, 3000K, 4000K, 6000K
Socket/ Input Voltage 12VCD
Size 42mm DIA X 20mm(H)
Ceiling cutout 35mm



R-D-203/xx-COB-3W-3K

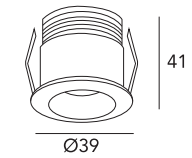

Description Recessed Fixed
Lamp Mini LED downlight with lens
 COB LED1W, 45lm,
 COB LED 3W, 110lm
Beam /Color 10°, 24°, 38°
Color 2700K, 3000K, 4000K, 6000K
Socket/ Input Voltage 12VDC
Size 39mmDIA X 41mm(H)
Ceiling cutout 35mm DIA



R-A-201/xx-COB-1W-3K

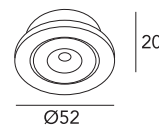

Description Recessed Adj. Mini LED downlight
Lamp COB LED 1W, 67lm
 COB LED 3W, 155m
Beam 10°, 24°, 38°
Color 2700K, 3000K, 3500K, 4000K
 5000K, 6500K
Socket/ Input Voltage 12V DC
Size 52mm DIA X 20mm(H)
Ceiling cutout 45mm



R-A-202/xx-COB-1W-3K

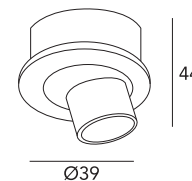

Description Recessed Fully Adj.
Lamp Mini LED downlight with snoot
 COB LED1W, 45lm,
 COB LED 3W, 110lm
Beam /Color 10°, 24°, 60°
Color 2700K, 3000K, 4000K, 6000K
Socket/ Input Voltage 12VDC
Size 39mmDIA X 44mm(H)
Ceiling cutout 27mm DIA



R-D-202/xx-COB-1W-3K

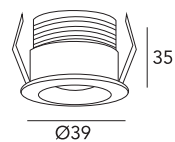

Description Recessed Fixed
Lamp Mini LED downlight
 LED 3W, 110lm
Beam /Color 10°, 24°, 38°
Color 2700K, 3000K, 4000K, 6000K
Socket/ Input Voltage 12VDC
Size 39mmDIA X 35mm(H)
Ceiling cutout 35mm DIA

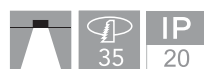

R-A-203/xx-COB-1W-3K

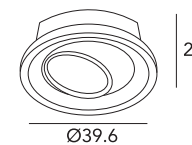

Description Recessed Fully Adj.
Lamp Mini LED downlight
 COB LED1W, 45lm,
 COB LED 3W, 110lm
Beam 20°, 40°, 60°
Color 2700K, 3000K, 4000K, 6000K
Socket/ Input Voltage 12VDC
Size 39.6mmDIA X 25mm(H)
Ceiling cutout 36mm DIA





R-A-204/xx-COB-1W-3K

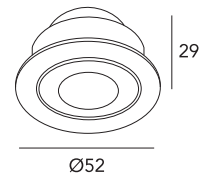

Description Recessed Adj. Mini LED downlight
Lamp COB LED1W, 45lm, COB LED 3W, 110lm
Beam /Color 20°, 40°, 60°
Color 2700K, 3000K, 4000K, 6000K
Socket/ Input Voltage 12VDC
Size 52mmDIA X 29mm(H)
Ceiling cutout 44mm DIA



R-D-205/xx-COB-8W-3K

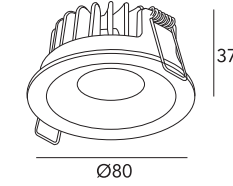

Description Recessed fixed LED downlight
Lamp 8W COB LED,655lm.
Socket/ Input Voltage 12V DC
Beam 20°, 40°, 60°
Color 2700K, 3000K, 4000K, 6000K
Size 80mm DIA. X 37mm(H)
Ceiling cut out 73mm DIA.



R-A-205/xx-COB-1W-3K

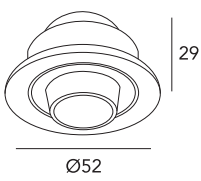

Description Recessed Adj. Mini LED downlight with snout
Lamp COB LED1W, 45lm, COB LED 3W, 110lm
Beam /Color 20°, 40°, 60°
Color 2700K, 3000K, 4000K, 6000K
Socket/ Input Voltage 12VDC
Size 52mmDIA X 29mm(H)
Ceiling cutout 44mm DIA



R-A-206/xx-COB-8W-3K

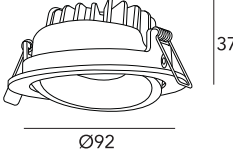

Description Recessed Adjustable LED downlight
Lamp 8W COB LED,655lm.
Socket/ Input Voltage 12V DC
Beam 20°, 40°, 60°
Color 2700K, 3000K, 4000K, 6000K
Size 92mm DIA. X 37mm(H)
Ceiling cut out 83mm DIA.



R-D-204/xx-COB-1W-3K

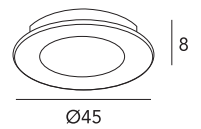

Description Recessed Fixed Mini LED downlight with lens
Lamp COB LED1W, 45lm, COB LED 3W, 110lm
Beam /Color 120°
Color 2700K, 3000K, 4000K, 6000K
Socket/ Input Voltage 12VDC
Size 45mmDIA X 8mm(H)
Ceiling cutout 42mm DIA

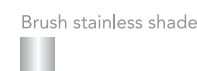
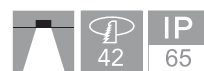

R-D-206/xx-COB-8W-3K

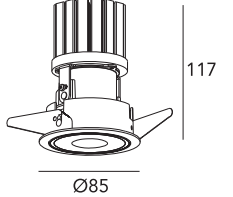

Description Recessed fixed pinhole LED downlight
Lamp 8W COB LED,432lm. 12W COB LED,588lm.
Socket/ Input Voltage 12V DC
Beam 20°, 40°, 60°
Color 2700K, 3000K, 4000K, 6000K
Size 85mm DIA. X 117mm(H)
Ceiling cut out 73mm DIA.





R-A-207/xx-COB-8W-3K

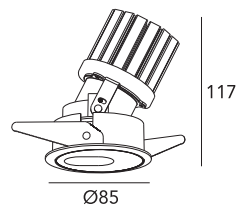

Description Recessed Adjustable pinhole LED downlight

Lamp 8W COB LED, 513lm.
12W COB LED, 690lm.

Socket/ Input Voltage 12V DC

Beam 20°, 40°, 60°

Color 2700K, 3000K, 4000K, 5000K

Size 85mm DIA. X 117mm(H)

Ceiling cut out 77mm DIA.



REFLECTOR OPTION

Trim

Trimless



Specular reflector Highest light output



Spherical facets reflector Uniform light beams, anti-glare



Frosted reflector anti-glare



Gold plated reflector



Black reflector anti-glare



White reflector anti-glare



Reflector with a fogproof glass



R-D-207/xx-COB-8W-3K

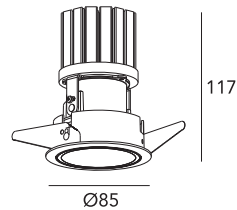

Description Recessed Fixed LED downlight

Lamp 8W COB LED, 700lm.
15W COB LED, 1150lm.

Socket/ Input Voltage 12V DC

Beam 20°, 40°, 60°

Color 2700K, 3000K, 4000K, 5000K

Size 85mm DIA. X 117mm(H)

Ceiling cut out 77mm DIA.

Note Reflector optional refer to page 52



R-A-208/xx-COB-8W-3K

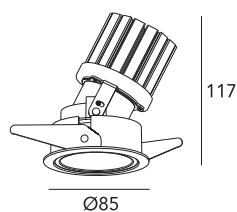

Description Recessed Adjustable LED downlight

Lamp 8W COB LED, 700lm.
15W COB LED, 1150lm.

Socket/ Input Voltage 12V DC

Beam 20°, 40°, 60°

Color 2700K, 3000K, 4000K, 5000K

Size 85mm DIA. X 117mm(H)

Ceiling cut out 77mm DIA.

Note Reflector optional refer to page 52





R-A-209/xx-COB-9W-3K

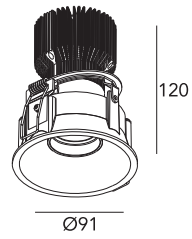

Description Recessed Fully Adj. LED downlight with snoot
Lamp 9W COB LED,945lm.
Socket/ Input Voltage 500mA
Beam 20°, 40°, 60°
Color 2700K, 3000K, 4000K, 5000K
Size 91mm DIA. X 120mm(H)
Ceiling cut out 83mm DIA.

Colour Optional



R-A-210/xx-COB-9W-3K

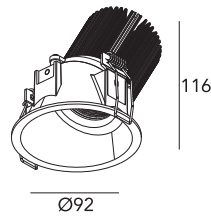

Description Recessed LED wall washer downlight
Lamp 9W COB LED,945lm.
Socket/ Input Voltage 500mA
Color 2700K, 3000K, 4000K, 5000K
Size 92mm DIA. X 116mm(H)
Ceiling cut out 83mm DIA.



R-A-211/xx-COB-5W-3K

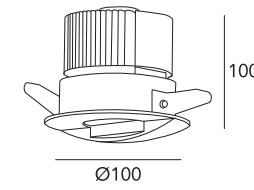

Description Recessed LED wall washer downlight
Lamp 5W COB LED,425lm.
Socket/ Input Voltage 12V DC
Color 2700K, 3000K, 3500K, 4000K, 5000K
Size 100mm DIA. X 100mm(H)
Ceiling cut out 90mm DIA.

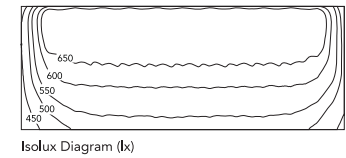
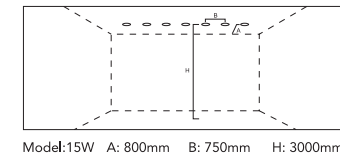
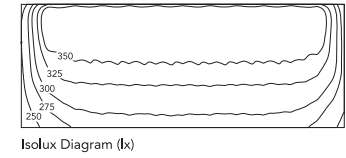
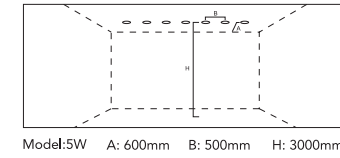

R-A-212/xx-COB-20W-3K

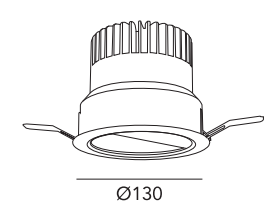

Description Recessed LED wall washer downlight
Lamp 20W COB LED, 1700lm.
Socket/ Input Voltage 12V DC
Color 2700K, 3000K, 3500K, 4000K, 5000K
Size 130mm DIA. X 113mm(H)
Ceiling cut out 125mm DIA.

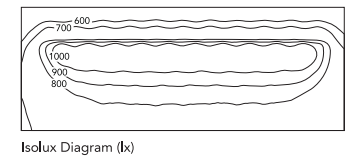
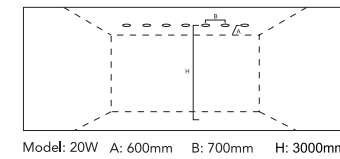
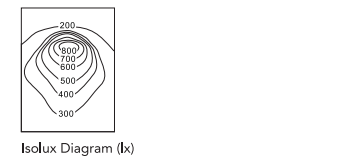
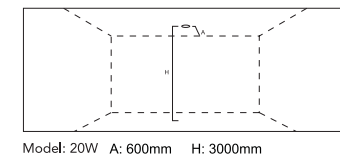



R-D-208/xx-COB-5W-3K

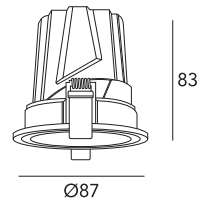

Description
Lamp
Recessed Fixed LED downlight
5W COB LED, 580lm.
7W COB LED, 750lm.

Socket/ Input Voltage 12V DC

Beam 24°, 36°, 60°

Color 3000K, 4000K, 6500K

Size 87mm DIA. X 83mm(H)

Ceiling cut out 75mm DIA.



Reflector Optional

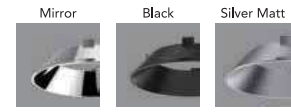

R-D-211/xx-COB-24W-3K

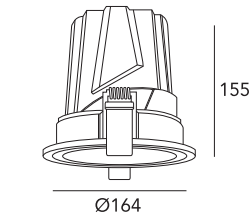

Description
Lamp
Recessed Fixed LED downlight
24W COB LED, 2900lm.
32W COB LED, 3700lm.

Socket/ Input Voltage 12V DC

Beam 24°, 36°, 60°

Color 3000K, 4000K, 6500K

Size 164mm DIA. X 155mm(H)

Ceiling cut out 150mm DIA.



Reflector Optional

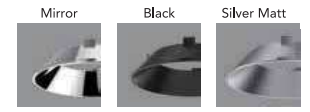

R-D-209/xx-COB-12W-3K

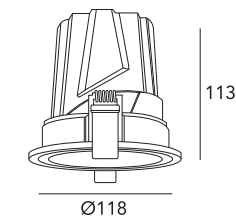

Description
Lamp
Recessed Fixed LED downlight
12W COB LED, 1200lm.

Socket/ Input Voltage 12V DC

Beam 24°, 36°, 60°

Color 3000K, 4000K, 6500K

Size 118mm DIA. X 113mm(H)

Ceiling cut out 100mm DIA.



Reflector Optional

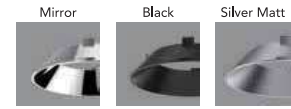

R-A-213/xx-COB-5W-3K

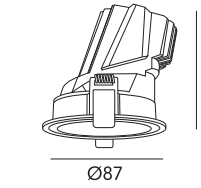

Description
Lamp
Recessed Adj. LED downlight
5W COB LED, 580lm.
7W COB LED, 750lm.

Socket/ Input Voltage 12V DC

Beam 24°, 36°, 60°

Color 3000K, 4000K, 6500K

Size 87mm DIA. X 83mm(H)

Ceiling cut out 75mm DIA.



Reflector Optional

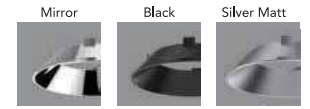

R-D-210/xx-COB-18W-3K

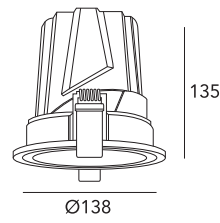

Description
Lamp
Recessed Fixed LED downlight
18W COB LED, 1670lm.

Socket/ Input Voltage 12V DC

Beam 24°, 36°, 60°

Color 3000K, 4000K, 6500K

Size 138mm DIA. X 135mm(H)

Ceiling cut out 125mm DIA.

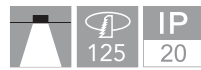

Reflector Optional

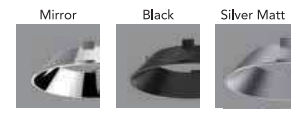

R-A-214/xx-COB-12W-3K

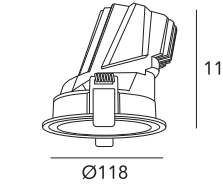

Description
Lamp
Recessed Adj. LED downlight
12W COB LED, 1200lm.

Socket/ Input Voltage 12V DC

Beam 24°, 36°, 60°

Color 3000K, 4000K, 6500K

Size 118mm DIA. X 113mm(H)

Ceiling cut out 100mm DIA.



Reflector Optional

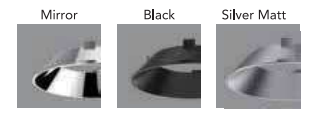



R-A-215/xx-COB-18W-3K

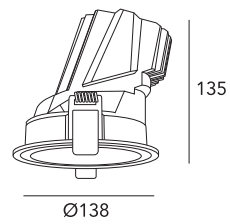

Description
Lamp
Socket/ Input Voltage
Beam
Color
Size
Ceiling cut out

Recessed Adj. LED downlight
18W COB LED, 1670lm.
12V DC
24°, 36°, 60°
3000K, 4000K, 6500K
138mm DIA. X 135mm(H)
125mm DIA.



Reflector Optional

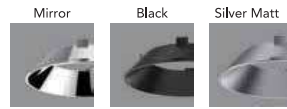

R-A-218/xx-COB-12W-3K

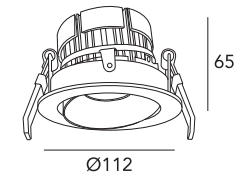

Description
Lamp
Socket/ Input Voltage
Beam
Color
Size
Ceiling cut out

Recessed Fully Adj. LED downlight
12W COB LED, 1200lm.
18W COB LED, 1670lm.
12V DC
24°, 36°, 60°
3000K, 4000K, 6500K
112mm DIA. X 65mm(H)
100mm DIA.



R-A-216/xx-COB-24W-3K

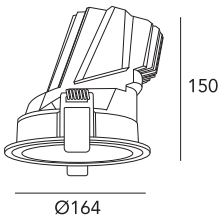

Description
Lamp
Socket/ Input Voltage
Beam
Color
Size
Ceiling cut out

Recessed Adj. LED downlight
24W COB LED, 2900lm.
32W COB LED, 3700lm.
12V DC
24°, 36°, 60°
3000K, 4000K, 6500K
164mm DIA. X 150mm(H)
150mm DIA.



Reflector Optional

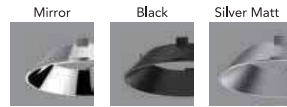

R-A-219/xx-COB-24W-3K

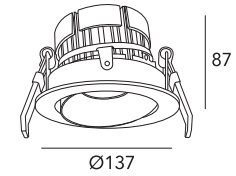

Description
Lamp
Socket/ Input Voltage
Beam
Color
Size
Ceiling cut out

Recessed Fully Adj. LED downlight
24W COB LED, 2900lm.
32W COB LED, 3700lm.
12V DC
24°, 36°, 60°
3000K, 4000K, 6500K
137mm DIA. X 87mm(H)
125mm DIA.



R-A-217/xx-COB-5W-3K

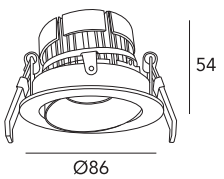

Description
Lamp
Socket/ Input Voltage
Beam
Color
Size
Ceiling cut out

Recessed Fully Adj. LED downlight
5W COB LED, 580lm.
7W COB LED, 750lm.
12V DC
24°, 36°, 60°
3000K, 4000K, 6500K
86mm DIA. X 54mm(H)
75mm DIA.



R-A-220/xx-COB-10W-3K

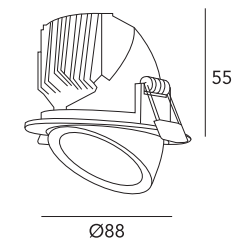

Description
Lamp
Socket/ Input Voltage
Beam
Color
Size
Ceiling cut out

Recessed Fully Adj. LED downlight
10W COB LED, 850lm.
220V-240V
15°, 24°, 32°
3000K, 3500K, 4000K
88mm DIA. X 55mm(H)
80mm DIA.





R-A-221/xx-COB-20W-3K

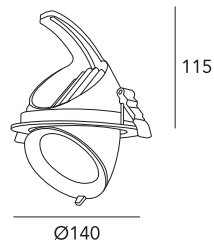

Description
Lamp

Recessed Fully Adj. LED downlight
20W COB LED, 1800lm.
25W COB LED, 2250lm.

Socket/ Input Voltage 12V DC

Beam 24°, 36°, 60°

Color 3000K, 3500K, 4000K

Size 140mm DIA. X 115mm(H)

Ceiling cut out 130mm DIA.



R-D-223/WH-SMD-7W-3K

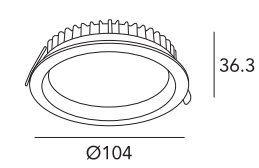

Description
Lamp

Recessed round LED panel
7W SMD LED, 595lm.
9W SMD LED, 765lm.
11W SMD LED, 935lm.

Socket/ Input Voltage 12V DC

Beam 90°

Color 2700K, 3000K, 3500K, 4000K, 5000K

Size 104mm DIA. X 36.3mm(H)

Ceiling cut out 90mm DIA.



R-A-222/xx-COB-30W-3K

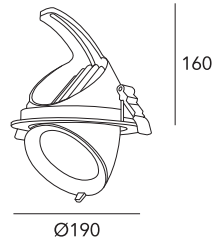

Description
Lamp

Recessed Fully Adj. LED downlight
30W COB LED, 2700lm.
40W COB LED, 3600lm.

Socket/ Input Voltage 12V DC

Beam 24°, 36°, 60°

Color 3000K, 4000K, 6500K

Size 190mm DIA. X 160mm(H)

Ceiling cut out 175mm DIA.



R-D-224/WH-SMD-15W-3K

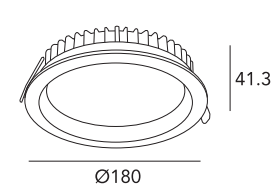

Description
Lamp

Recessed round LED panel
15W SMD LED, 1275lm.
20W SMD LED, 1700lm.
23W SMD LED, 1955lm.

Socket/ Input Voltage 12V DC

Beam 90°

Color 2700K, 3000K, 3500K, 4000K, 5000K

Size 180mm DIA. X 41.3mm(H)

Ceiling cut out 160mm DIA.



R-D-222/xx-SMD-5W-3K

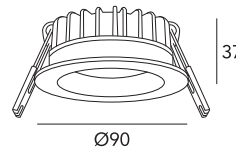

Description
Lamp

Recessed round LED panel
5W SMD LED, 425lm.
7W SMD LED, 595lm.

Socket/ Input Voltage 12V DC

Beam 90°

Color 2700K, 3000K, 3500K, 4000K, 5000K

Size 90mm DIA. X 37mm(H)

Ceiling cut out 70mm DIA.



R-D-225/WH-SMD-20W-3K

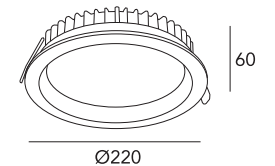

Description
Lamp

Recessed round LED panel
20W SMD LED, 1700lm.
23W SMD LED, 1955lm.
30W SMD LED, 2550lm.

Socket/ Input Voltage 12V DC

Beam 90°

Color 2700K, 3000K, 3500K, 4000K, 5000K

Size 220mm DIA. X 60mm(H)

Ceiling cut out 190mm DIA.

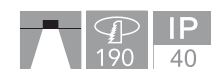



R-D-201/xx-COB-8W-3K

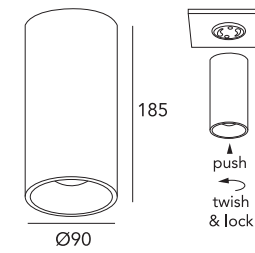

Description
Lamp

Surface mount LED downlight
COB LED 8W, 765lm
COB LED 12W, 1034lm
COB LED 15W, 1150lm

Beam
15°, 24°, 38°, 60°

Color
2700K, 3000K, 4000K, 5000K

Socket/ Input Voltage
500mA

Size
90mmDIA X 185mm(H)

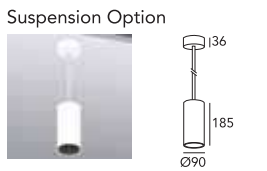

S-D-202/xx-COB-15W-3K

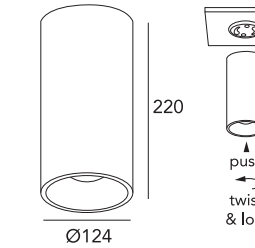

Description
Lamp

Surface mount LED downlight
COB LED 15W, 1350lm
COB LED 23W, 1980lm

Beam
15°, 24°, 38°, 60°

Color
2700K, 3000K, 4000K, 5000K

Socket/ Input Voltage
500mA

Size
124mmDIA X 220mm(H)

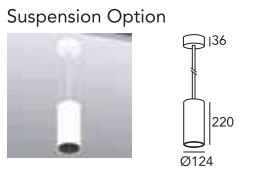

S-D-203/xx-COB-12W-3K

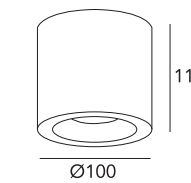

Description
Lamp

Surface mount LED downlight
with reflector
COB LED 12W, 1200lm

Beam /Color
15°, 24°, 36°

Color
3000K, 4000K, 6500K

Socket/ Input Voltage
500mA

Size
100mmDIA X 110mm(H)





S-D-203/xx-COB-18W-3K

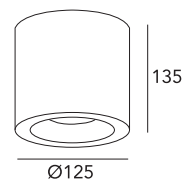

Description Surface mount LED downlight with reflector

Lamp COB LED 18W, 1670lm

Beam /Color 15°, 24°, 36°

Color 3000K, 4000K, 6500K

Socket/ Input Voltage 500mA

Size 125mmDIA X 135mm(H)



S-D-204/xx-COB-24W-3K

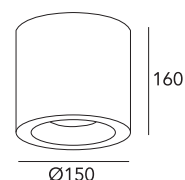

Description Surface mount LED downlight with reflector

Lamp COB LED 24W, 2900lm
COB LED 32W, 3700lm

Beam 15°, 24°, 36°

Color 3000K, 4000K, 6500K

Socket/ Input Voltage 500mA

Size 150mmDIA X 160mm(H)



S-A-R-201/xx-COB-7W-3K

S-A-R-201/xx-COB-18W-3K

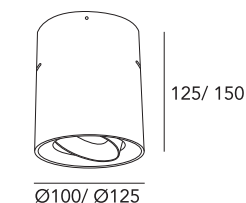

Description Surface mount accent round downlight

Lamp COB LED 7W, 750lm
COB LED 12W, 1200lm
COB LED 18W, 1670lm

Beam 15°, 24°, 36°

Color 3000K, 4000K, 6500K

Socket/ Input Voltage 500mA

Size (7W, 12W) 100mmDIA X 125mm(H)
(18W) 125mmDIA X 150mm(H)

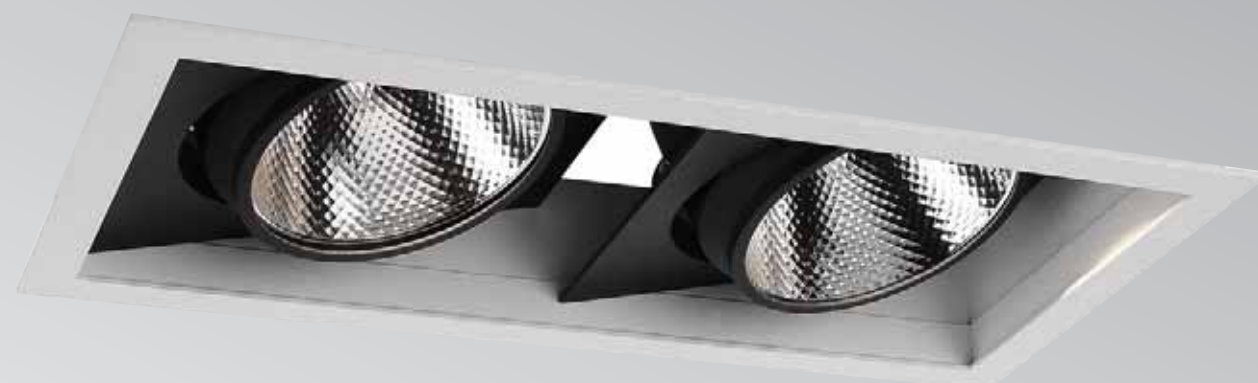



R-SQ-201/xx-COB-7W-3K

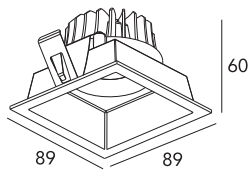

Description Recessed fixed square LED downlight
Lamp 7W COB LED, 659lm
Socket/ Input Voltage 37V 300mA
Beam 25°, 38°, 60°
Color 2700K, 3000K, 4000K, 5000K
Size 89mm Square X 60mm(H)
Ceiling cut out 80mm X 80mm.
Note: Smooth Reflector

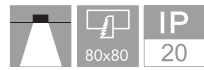

R-SQ-202/xx-COB-2x7W-3K

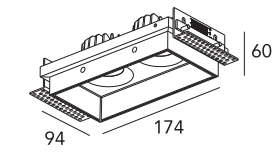

Description Recessed fixed rectangular LED trimless downlight
Lamp (2)7W COB LED, (2)659lm
Socket/ Input Voltage 37V 300mA
Beam 25°, 38°, 60°
Color 2700K, 3000K, 4000K, 5000K
Size 94mm(W) 174mm(L) X 60mm(H)
Ceiling cut out 83mm X 163mm.
Note: Smooth Reflector



R-SQ-201/xx-COB-2x7W-3K

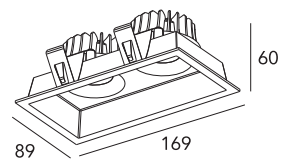

Description Recessed fixed rectangular LED downlight
Lamp (2)7W COB LED, (2)659lm
Socket/ Input Voltage 37V 300mA
Beam 25°, 38°, 60°
Color 2700K, 3000K, 4000K, 5000K
Size 89mm(W) 169mm(L) X 60mm(H)
Ceiling cut out 80mm X 160mm.
Note: Smooth Reflector



R-SQ-203/xx-COB-8W-3K

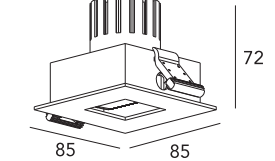

Description Recessed Fixed Pinhole square LED downlight
Lamp 8W COB LED, 395lm.
 12W COB LED, 560lm.
Socket/ Input Voltage 37V 300mA
Beam 12°, 24°, 38°
Color 2700K, 3000K, 4000K, 6500K
Size 85mm sq X 72mm(H)
Ceiling cut out 73mm sq
Accessories Lesns /Honey comb



R-SQ-202/xx-COB-7W-3K

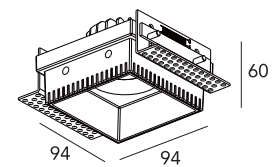

Description Recessed fixed square LED trimless downlight
Lamp 7W COB LED, 659lm
Socket/ Input Voltage 37V 300mA
Beam 25°, 38°, 60°
Color 2700K, 3000K, 4000K, 5000K
Size 94mm square X 60mm(H)
Ceiling cut out 83mm X 83mm.
Note: Smooth Reflector

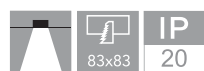

A-SQ-203/xx-COB-8W-3K

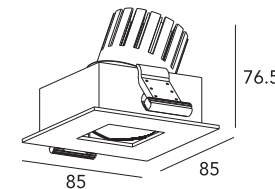

Description Recessed Adj. Pinhole square LED downlight
Lamp 8W COB LED, 395lm.
 12W COB LED, 560lm.
Socket/ Input Voltage 37V 300mA
Beam 12°, 24°, 38°
Color 3000K, 4000K, 6500K
Size 85mm sq X 76.5mm(H)
Ceiling cut out 73mm sq
Accessories Lens /Honey comb



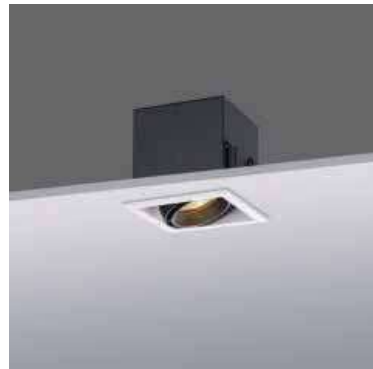

A-SQ-202/xx-COB-8W-3K

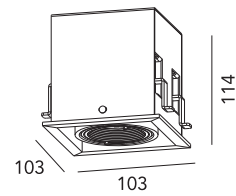

Description Recessed Fully Adj.
Square LED downlight
Lamp 8W COB LED, 654lm
12W COB LED, 888lm
Socket/ Input Voltage 37V 300mA
Beam 24°, 40°
Color 2700K, 3000K, 4000K, 5000K
Size 103mm sq X 114mm(H)
Ceiling cut out 93mm X 93mm



Snoot Optional

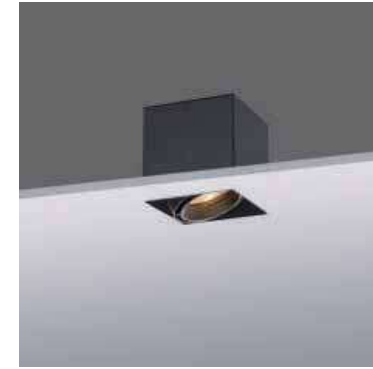

A-SQ-203/xx-COB-8W-3K

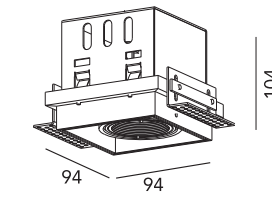

Description Recessed fully Adj.
Trimless square LED downlight
Lamp 8W COB LED, 654lm
12W COB LED, 888lm
Socket/ Input Voltage 37V 300mA
Beam 24°, 40°
Color 2700K, 3000K, 4000K, 5000K
Size 94mm sq X 104mm(H)
Ceiling cut out 95mm X 95mm



Snoot Optional



A-SQ-202/xx-COB-2x8W-3K

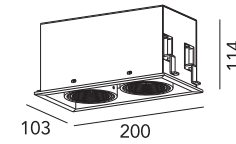

Description Recessed Fully Adj.
Rectangular LED downlight
Lamp (2)8W COB LED, 1308lm
(2)12W COB LED, 1776lm
Socket/ Input Voltage 37V 300mA
Beam 24°, 40°
Color 2700K, 3000K, 4000K, 5000K
Size 103mm(W) X 200mm(L) X 114mm(H)
Ceiling cut out 93mm X 190mm



Snoot Optional



A-SQ-203/xx-COB-2x8W-3K

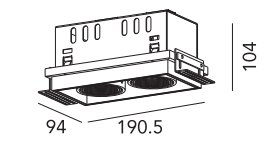

Description Recessed Fully Adj. trimless
Rectangular LED downlight
Lamp (2)8W COB LED, 1308lm
(2)12W COB LED, 1776lm
Socket/ Input Voltage 37V 300mA
Beam 24°, 40°
Color 2700K, 3000K, 4000K, 5000K
Size 94mm(W) X 190.5mm(L) X 104mm(H)
Ceiling cut out 95mm X 191mm



Snoot Optional



A-SQ-202/xx-COB-3x8W-3K

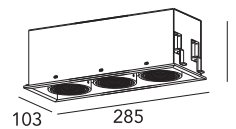

Description Recessed Fully Adj.
Rectangular LED downlight
Lamp (3)8W COB LED, 1962lm
(3)12W COB LED, 2664lm
Socket/ Input Voltage 37V 300mA
Beam 24°, 40°
Color 2700K, 3000K, 4000K, 5000K
Size 103mm (W) X 285mm(L) X 120mm(H)
Ceiling cut out 93mm X 275mm



Snoot Optional



A-SQ-203/xx-COB-3x8W-3K

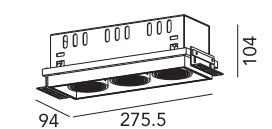

Description Recessed Fully Adj. trimless
Rectangular LED downlight
Lamp (3)8W COB LED, 1962lm
(3)12W COB LED, 2664lm
Socket/ Input Voltage 37V 300mA
Beam 24°, 40°
Color 2700K, 3000K, 4000K, 5000K
Size 94mm(W) X 275.5mm(L) X 104mm(H)
Ceiling cut out 95mm X 276mm



Snoot Optional





A-SQ-204/xx-COB-18W-3K

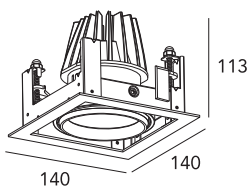

Description Recessed Fully Adj. Square LED downlight
18W COB LED, 1670lm.

Lamp

Socket/ Input Voltage 12V DC

Beam 15°, 24°, 36°

Color 3000K, 4000K

Size 140mm sq X 113mm(H)

Ceiling cut out 125mm sq



A-SQ-205/xx-COB-24W-3K

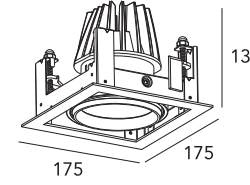

Description Recessed Fully Adj. Square LED downlight
24W COB LED, 2900lm.
32W COB LED, 3700lm.

Lamp

Socket/ Input Voltage 12V DC

Beam 15°, 24°, 36°

Color 3000K, 4000K

Size 175mm sq X 133mm(H)

Ceiling cut out 125mm sq



A-SQ-204/xx-COB-2x18W-3K

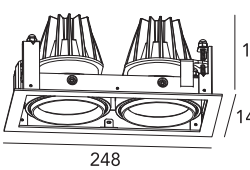

Description Recessed Fully Adj. Rectangular LED downlight
(2)18W COB LED, (2)1670lm.

amp

Socket/ Input Voltage 12V DC

Beam 15°, 24°, 36°

Color 3000K, 4000K

Size 140mm(W) X 248mm(L) X 113mm(H)

Ceiling cut out 125mm X 234mm



A-SQ-205/xx-COB-2x24W-3K

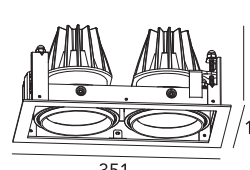

Description Recessed Fully Adj. Rectangular LED downlight
(2)24W COB LED, (2)2900lm.
(2)32W COB LED, (2)3700lm.

Lamp

Socket/ Input Voltage 12V DC

Beam 15°, 24°, 36°

Color 3000K, 4000K

Size 175mm(W) X 351mm(L) X 133mm(H)

Ceiling cut out 125mm X 234mm



A-SQ-204/xx-COB-3x18W-3K

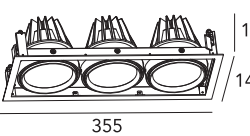

Description Recessed Fully Adj. Rectangular LED downlight
(3)18W COB LED, (3)1670lm.

amp

Socket/ Input Voltage 12V DC

Beam 15°, 24°, 36°

Color 3000K, 4000K

Size 140mm(W) X 355mm(L) X 113mm(H)

Ceiling cut out 125mm X 340mm



A-SQ-205/xx-COB-3x24W-3K

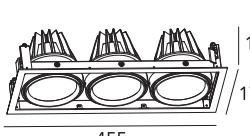

Description Recessed Fully Adj. Rectangular LED downlight
(3)24W COB LED, (3)2900lm.
(3)32W COB LED, (3)3700lm.

Lamp

Socket/ Input Voltage 12V DC

Beam 15°, 24°, 36°

Color 3000K, 4000K

Size 175mm(W) X 455mm(L) X 133mm(H)

Ceiling cut out 125mm X 340mm





A-SQ-206/xx-COB-23W-3K

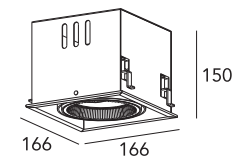

Description Recessed fully Adj. LED square downlight

Lamp COB LED 23W, 2200lm
COB LED 36W, 3200lm
COB LED 42W, 3600lm

Beam 16°, 26°, 40°, 60°

Color 2700K, 3000K, 4000K, 5000K

Socket/ Input Voltage 32V 700mA

Size 166mm sq X 150mm(H)

Ceiling cutout 156mm sq



A-SQ-206/xx-COB-2x23W-3K

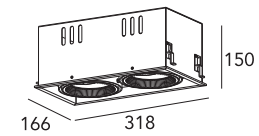

Description Recessed fully Adj. LED square downlight

Lamp (2)COB LED 23W, 2200lm
(2)COB LED 36W, 3200lm
(2)COB LED 42W, 3600lm

Beam 16°, 26°, 40°, 60°

Color 2700K, 3000K, 4000K, 5000K

Socket/ Input Voltage 32V 700mA

Size 166mm(W) X 318mm(L) X 150mm(H)

Ceiling cutout 156mm X 308mm



A-SQ-206/xx-COB-3x23W-3K

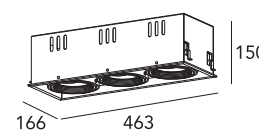

Description Recessed fully Adj. LED square downlight

Lamp (3)COB LED 23W, 2200lm
(3)COB LED 36W, 3200lm
(3)COB LED 42W, 3600lm

Beam 16°, 26°, 40°, 60°

Color 2700K, 3000K, 4000K, 5000K

Socket/ Input Voltage 32V 700mA

Size 166mm(W) X 463mm(L) X 150mm(H)

Ceiling cutout 156mm X 453mm



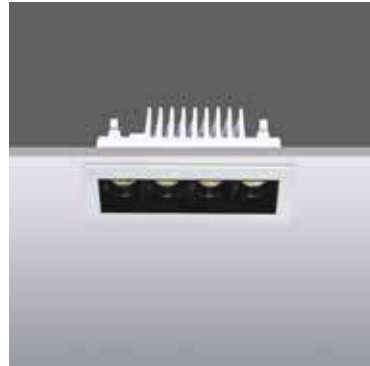

R-SQ-204/xx-COB-10W-3K

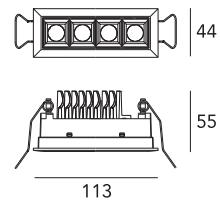

Description Recessed line LED system downlight
Lamp COB LED 10W, 744lm
Beam 13°, 29°, 41°, 52°, 16° X 36°
Color 2700K, 3000K, 4000K, 5000K
Socket/ Input Voltage 12V 700mA
Size 44mm(W) 113mm(L) X 55mm(H)
Ceiling cut out 36mm X 105mm

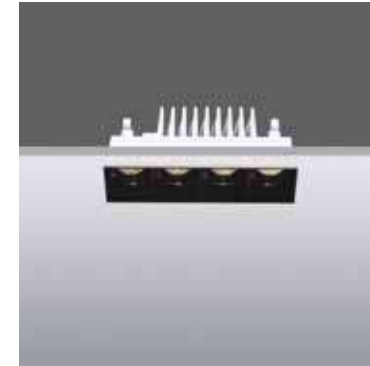

R-SQ-207/xx-COB-10W-3K

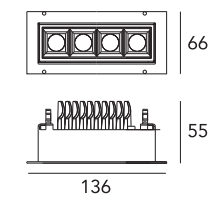

Description Recessed line LED system trimless downlight
Lamp COB LED 10W, 744lm
Beam 13°, 29°, 41°, 52°, 16° X 36°
Color 2700K, 3000K, 4000K, 5000K
Socket/ Input Voltage 12V 700mA
Size 66mm(W) 136mm(L) X 55mm(H)
Ceiling cut out 40mm X 113mm

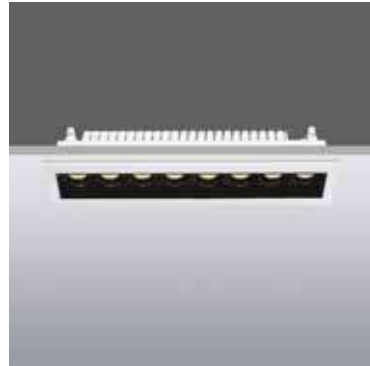

R-SQ-205/xx-COB-20W-3K

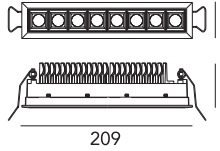

Description Recessed line LED system downlight
Lamp COB LED 20W, 1600lm
Beam 13°, 29°, 41°, 52°, 16° X 36°
Color 2700K, 3000K, 4000K, 5000K
Socket/ Input Voltage 27V 700mA
Size 44mm(W) 209mm(L) X 55mm(H)
Ceiling cut out 36mm X 203mm

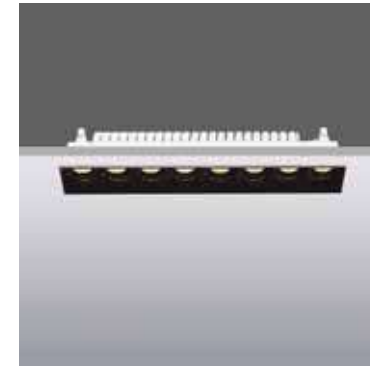

R-SQ-208/xx-COB-20W-3K

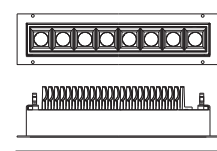

Description Recessed line LED system trimless downlight
Lamp COB LED 20W, 1600lm
Beam 13°, 29°, 41°, 52°, 16° X 36°
Color 2700K, 3000K, 4000K, 5000K
Socket/ Input Voltage 27V 700mA
Size 66mm(W) 231mm(L) X 55mm(H)
Ceiling cut out 40mm X 210mm

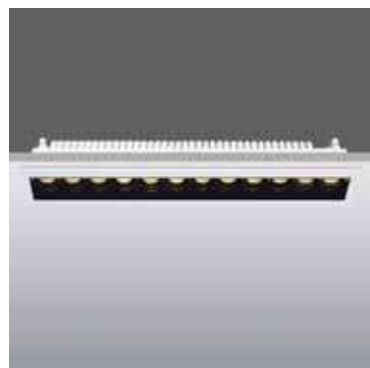

R-SQ-206/xx-COB-30W-3K

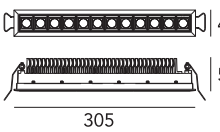

Description Recessed line LED system downlight
Lamp COB LED 30W, 2200lm
Beam 13°, 29°, 41°, 52°, 16° X 36°
Color 2700K, 3000K, 4000K, 5000K
Socket/ Input Voltage 30V 700mA
Size 44mm(W) 305mm(L) X 55mm(H)
Ceiling cut out 36mm X 298mm

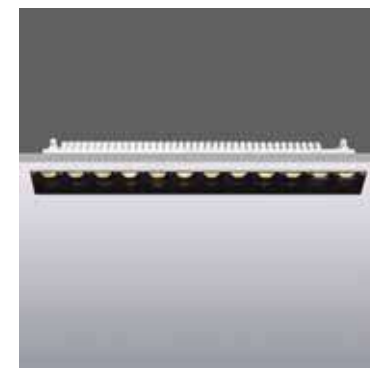

R-SQ-209/xx-COB-30W-3K

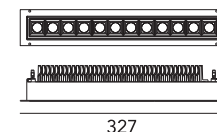

Description Recessed line LED system trimless downlight
Lamp COB LED 30W, 2200lm
Beam 13°, 29°, 41°, 52°, 16° X 36°
Color 2700K, 3000K, 4000K, 5000K
Socket/ Input Voltage 30V 700mA
Size 66mm(W) 327mm(L) X 55mm(H)
Ceiling cut out 40mm X 304mm





R-SQ-210/xx-SMD-7W-3K

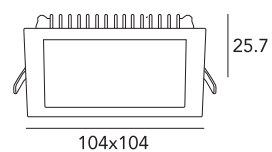

Description
Lamp

Recessed square LED panel
7W SMD LED, 595lm.
9W SMD LED, 765lm.
11W SMD LED, 935lm.

Socket/ Input Voltage 12V DC

Beam 90°

Color 2700K, 3000K, 3500K, 4000K, 5000K

Size 104mm sq X 25.7mm(H)

Ceiling cut out 90mm sq



R-SQ-211/xx-SMD-11W-3K

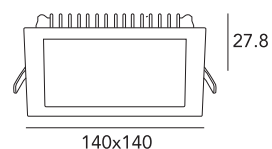

Description
Lamp

Recessed square LED panel
11W SMD LED, 935lm.
15W SMD LED, 1275lm.

Socket/ Input Voltage 12V DC

Beam 90°

Color 2700K, 3000K, 3500K, 4000K, 5000K

Size 140mm sq X 27.8mm(H)

Ceiling cut out 125mm sq



R-SQ-212/xx-SMD-15W-3K

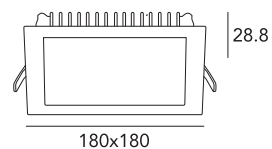

Description
Lamp

Recessed square LED panel
15W SMD LED, 1275lm.
20W SMD LED, 1680lm.
23W SMD LED, 1955lm.

Socket/ Input Voltage 12V DC

Beam 90°

Color 2700K, 3000K, 3500K, 4000K, 5000K

Size 180mm sq X 28.8mm(H)

Ceiling cut out 160mm sq





S-SQ-201/xx-COB-12W-3K

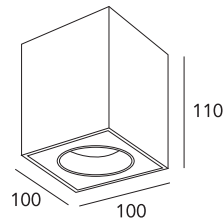

Description Surface mount square LED downlight with reflector
Lamp 12W COB LED, 1200lm
Socket/ Input Voltage 37V 300mA
Beam 15°, 24°, 36°
Color 3000K, 4000K
Size 100mm sq X 110mm(H)



S-SQ-204/xx-COB-8W-3K

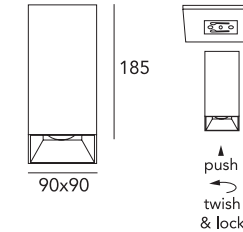

Description Surface mount square LED downlight
Lamp 8W COB LED, 765lm
 12W COB LED, 1034lm
 15W COB LED, 1150lm
Socket/ Input Voltage 37V 300mA
Beam 15°, 24°, 38°, 60°
Color 2700K, 3000K, 4000K, 5000K
Size 90mm sq X 185mm(H)

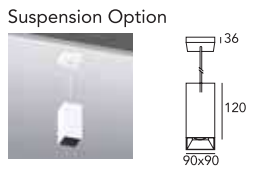

S-SQ-202/xx-COB-18W-3K

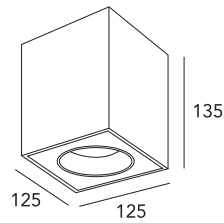

Description Surface mount square LED downlight with reflector
Lamp 18W COB LED, 1670lm
Socket/ Input Voltage 37V 300mA
Beam 15°, 24°, 36°
Color 3000K, 4000K
Size 125mm sq X 135mm(H)



S-SQ-205/xx-COB-15W-3K

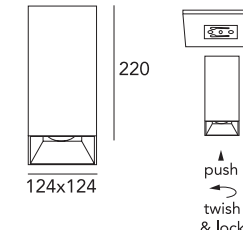

Description Surface mount square LED downlight
Lamp 15W COB LED, 1284lm
 23W COB LED, 2015lm
Socket/ Input Voltage 37V 300mA
Beam 15°, 38°, 60°
Color 2700K, 3000K, 4000K, 5000K
Size 124mm sq X 220mm(H)

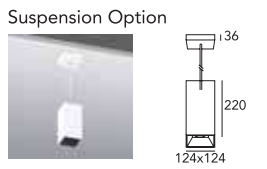

S-SQ-203/xx-COB-24W-3K

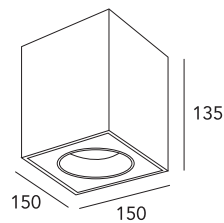

Description Surface mount square LED downlight with reflector
Lamp 24W COB LED, 2900lm
 32W COB LED, 3700lm
Socket/ Input Voltage 37V 300mA
Beam 15°, 24°, 36°
Color 3000K, 4000K
Size 150mm sq X 135mm(H)



S-A-SQ-201/xx-COB-15W-3K

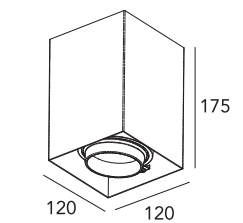

Description Surface mount fully Adj. rectangular LED downlight with snoot
Lamp 15W COB LED, 975lm
 20W COB LED, 1300lm
Socket/ Input Voltage 37V 300mA
Beam 15°, 24°, 36°, 60°
Color 2700K, 3000K, 3500K, 4000K, 5000K
Size 120mm sq X 175mm(H)





S-A-SQ-201/xx-COB-2x15W-3K

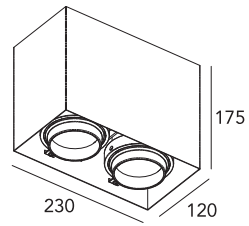

Description Surface mount fully Adj. rectangular LED downlight with snoot

Lamp (2)15W COB LED, (2)975lm
(2)20W COB LED, (2)1300lm

Socket/ Input Voltage 37V 300mA

Beam 15°, 24°, 36°, 60°

Color 2700K, 3000K, 3500K, 4000K, 5000K

Size 120mm(W) 230mm(L) X 175mm(H)



S-A-SQ-202/xx-COB-25W-3K

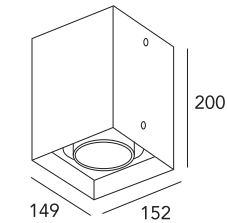

Description Surface mount fully Adj. square downlight

Lamp 25W COB LED, 1750lm

Socket/ Input Voltage 37V 300mA

Beam 15°, 24°, 38°

Color 3000K, 4000K, 5000K

Size 149mm(W) 152mm(L) X 200mm(H)



S-A-SQ-202/xx-COB-2x25W-3K

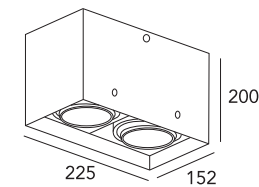

Description Surface mount fully Adj. Rectangular downlight

Lamp (2)25W COB LED, (2)1750lm

Socket/ Input Voltage 37V 300mA

Beam 15°, 24°, 38°

Color 3000K, 4000K, 5000K

Size 152mm(W) 225mm(L) X 200mm(H)



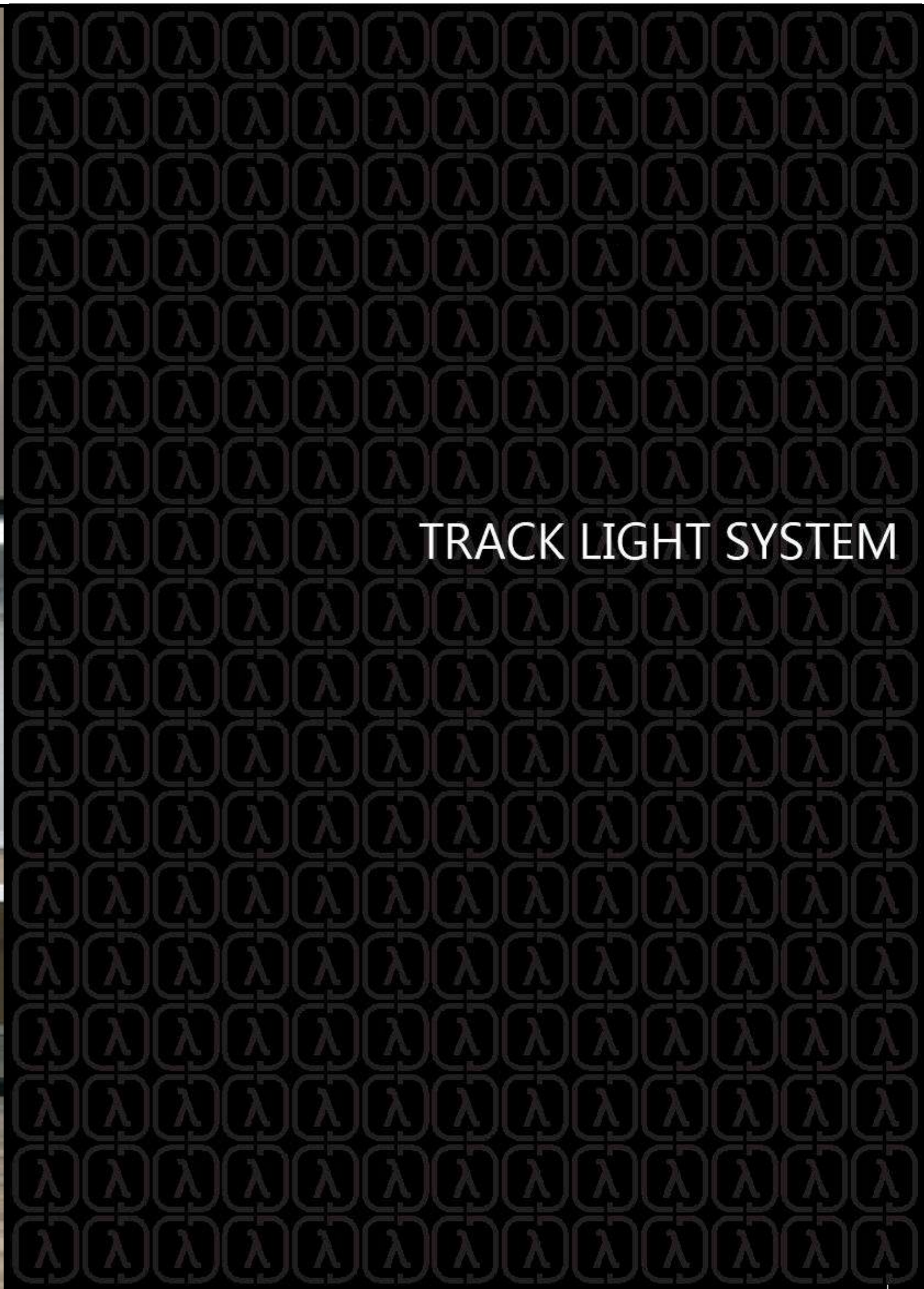

TRACK LIGHT SYSTEM



T-101/xx-PAR16

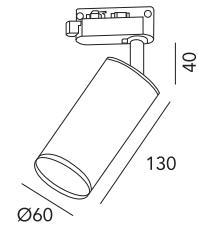

Description Surface mount Fully Adj. track spotlight
Lamp PAR16
Beam 36°
Socket/ Input Voltage GU10, 220V
Size 60mm DIA X 130mm(H)
Accessories Honey comb



T-104/xx-AR111

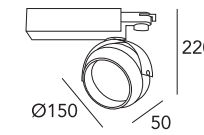

Description Surface mount Fully Adj. track spotlight
Lamp AR111
Beam 15°, 25°, 40°
Socket/Input Voltage G53, 12VDC
Size 150mm DIA X 220mm(H)



T-102/xx-MR16

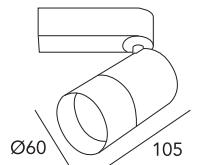

Description Surface mount Fully Adj. track spotlight
Lamp MR16
Beam 15°, 24°, 36°, 60°
Socket/ Input Voltage GU5.3, 12VDC
Size 60mm DIA X 105mm(L)
Accessories Honey comb



T-105/xx-PAR30

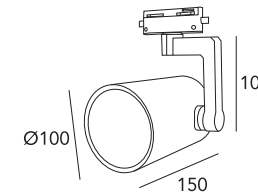

Description Surface mount Fully Adj. track spotlight
Lamp PAR30
Beam /Color 15°, 25°, 40°
Socket/ Input Voltage E27/220V
Size 100mmDIA X 150mm(L)



T-103/xx-AR111

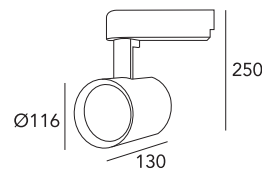

Description Surface mount Fully Adj. track spotlight
Lamp AR111
Beam 15°, 25°, 40°
Socket/Input Voltage G53, 12VDC
Size 116mm DIA X 130mm(L)



T-106/xx-PAR30

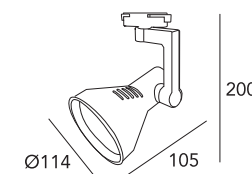

Description Surface mount Fully Adj. track spotlight
Lamp PAR30
Beam /Color 15°, 25°, 40°
Socket/ Input Voltage E27/220V
Size 114mmDIA X 105mm(L)





S-T-107/xx-PAR16

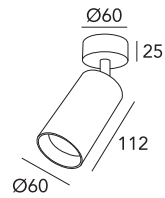

Description
Fully Adj. spotlight with mounting base

Lamp
PAR16

Socket/ Input Voltage
GU10/220V

Beam /Color
15°, 24°, 36°, 60°

Size
60mm DIA X 112mm(H)



S-T-201/xx-COB-8W-xK

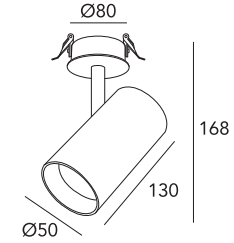

Description
Fully Adj. spotlight with recessed mounting base

Lamp
8W COB LED, 700lm
12W COB LED, 980lm
15W COB LED, 1200lm

Beam
15°, 24°, 38°

Color
2700K, 3000K, 4000K, 5000K

Socket/Input Voltage
38V 300mA

Size
50mm DIA. X 168mm(H)

Cutout
64mm. DIA



R-T-201/xx-8W-xK

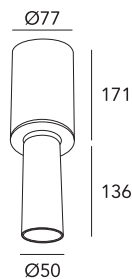

Description
Recessed Adj. LED spotlight

Lamp
8W COB LED, 700lm
12W COB LED, 980lm
15W COB LED, 1200lm

Beam
15°, 24°, 38°

Color
2700K, 3000K, 4000K, 5000K

Socket/Input Voltage
38V 300mA

Size
77mm DIA. X 171mm(H)

Cutout
77mm. DIA



S-T-202/xx-COB-15W-xK

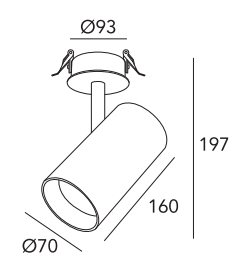

Description
Fully Adj. spotlight with recessed mounting base

Lamp
15W COB LED, 1137lm
20W COB LED, 1376lm

Beam
15°, 24°, 38°

Color
2700K, 3000K, 4000K, 5000K

Socket/Input Voltage
38V 300mA

Size
70mm DIA. X 197mm(H)

Cutout
76mm. DIA



R-T-202/xx-15W-xK

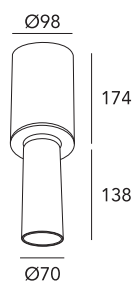

Description
Recessed Adj. LED spotlight

Lamp
15W COB LED, 1137lm
20W COB LED, 1376lm

Beam
15°, 24°, 38°

Color
2700K, 3000K, 4000K, 5000K

Socket/Input Voltage
38V 300mA

Size
98mm DIA. X 174mm(H)

Cutout
98mm. DIA



S-T-203/xx-COB-23W-xK

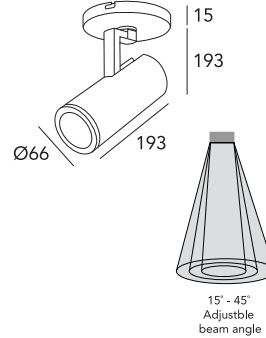

Description
Fully Adj. zoomable track head monopoint mount

Lamp
23W COB LED, 1275lm

Beam
Adjustable beam 15°- 45°

Color
3000K, 3500K, 4000K

Socket/Input Voltage
300mA

Size
66mm DIA X 193mm(L)

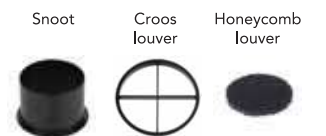



T-201/xx-COB-8W-xK

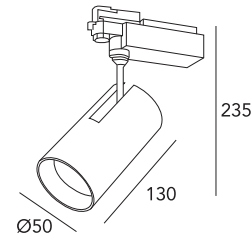

Description Surface mount Fully Adj. track spotlight
Lamp 8W COB LED, 700lm
 12W COB LED, 980lm
 15W COB LED, 1200lm
Beam 15°, 24°, 38°
Color 2700K, 3000K, 4000K, 5000K
Input Voltage 38V 300mA
Size 50mm DIA X 235mm(H)



T-204/xx-COB-23W-xK

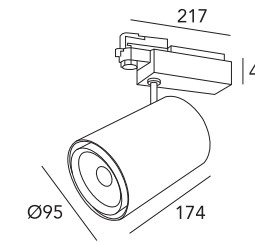

Description Surface mount Fully Adj. track spotlight
Lamp 23W COB LED, 1955lm
 32W COB LED, 2656lm
Beam 15°, 24°, 38°
Color 2700K, 3000K, 4000K, 5000K
Input Voltage 38V 300mA
Size 95mm DIA X 174mm(L)



T-202/xx-COB-15W-xK

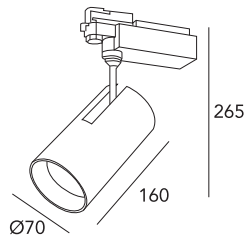

Description Surface mount Fully Adj. track spotlight
Lamp 15W COB LED, 1275lm
 23W COB LED, 1910lm
Beam 15°, 24°, 38°
Color 2700K, 3000K, 4000K, 5000K
Input Voltage 38V 300mA
Size 70mm DIA X 160mm(H)



T-205/xx-COB-22W-xK

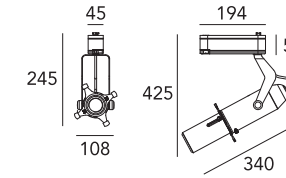

Description Surface mount Fully Adj. track Projector
Lamp 22.5W COB LED
Beam Adjustable beam 15°- 45°
Color 3000K, 3500K, 4000K
Socket/Input Voltage 12VAC
Size 108mm(W) X 340mm(L) X 245mm(H)

T-203/xx-COB-15W-xK

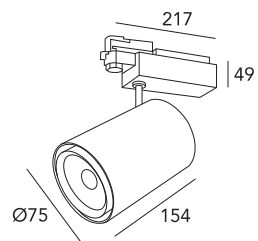

Description Surface mount Fully Adj. track spotlight
Lamp 15W COB LED, 1275lm
 23W COB LED, 1910lm
Beam 15°, 24°, 38°
Color 2700K, 3000K, 4000K, 5000K
Input Voltage 38V 300mA
Size 75mm DIA X 154mm(H)



Application Performance
 Bridgelux Vero 10, 3000K
 Narrow Focus
 WideFocus

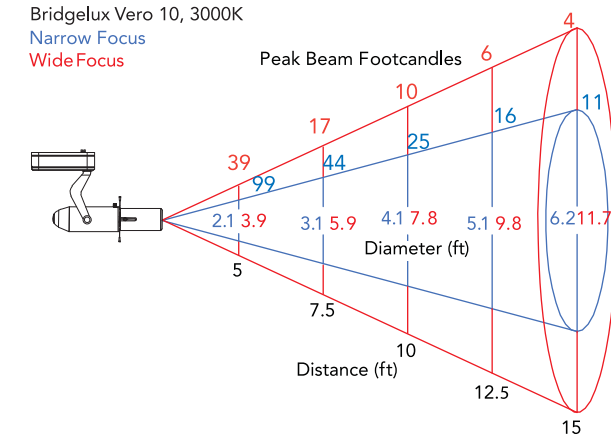

Monopoint base



Colored Lens



Gobo Lens





T-206/xx-COB-5W-xK

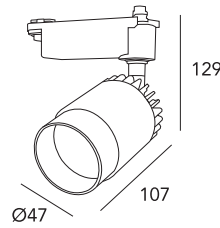

Description
 Surface mount Fully Adj. track spotlight with honeycomb
Lamp
 5W COB LED, 375lm
 8W COB LED, 600lm
Beam
 Adjustable beam 15°- 50°
Color
 3000K, 3500K, 4000K
Input Voltage
 220V
Size
 47mm DIA X 107mm(L)

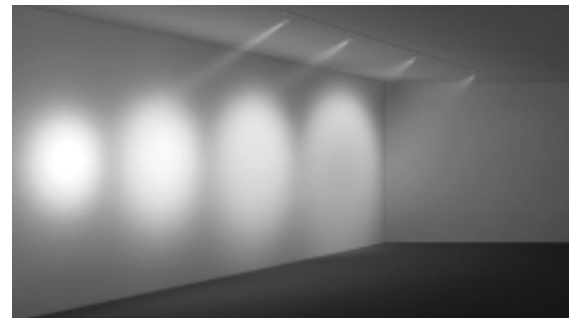
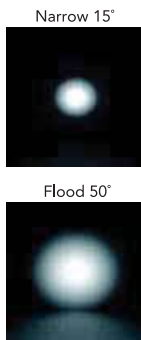
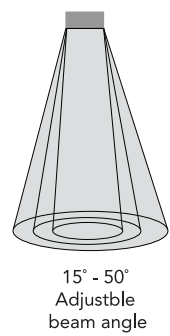

T-208/xx-COB-35W-xK

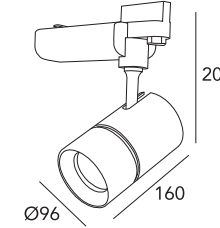

Description
 Surface mount Fully Adj. track spotlight
Lamp
 35W COB LED, 3150lm
Beam
 Adjustable beam 15°- 50°
Color
 3000K, 3500K, 4000K
Input Voltage
 220V
Size
 96mm DIA X 160mm(L)

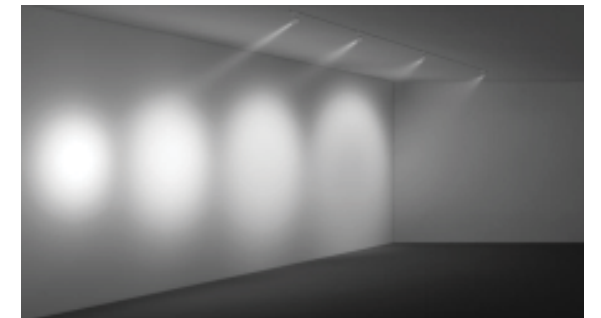
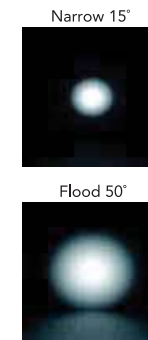
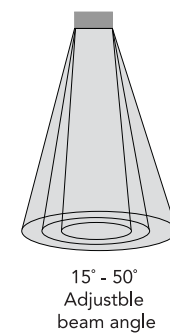

T-207/xx-COB-10W-xK

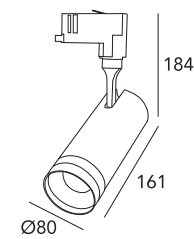

Description
 Surface mount Fully Adj. track spotlight
Lamp
 10W COB LED, 850lm
 15W COB LED, 1275lm
Beam
 Adjustable beam 15°- 50°
Color
 3000K, 3500K, 4000K
Input Voltage
 220V
Size
 80mm DIA X 184mm(L)

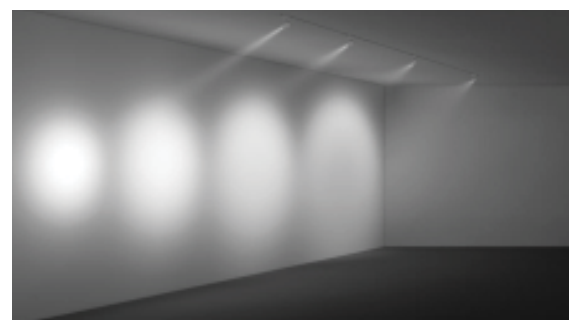
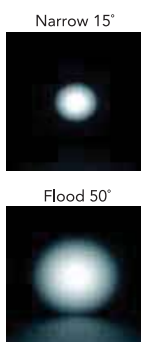
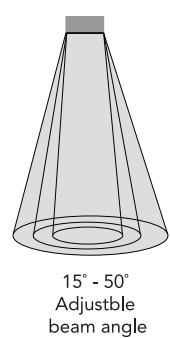

T-209/xx-COB-50W-xK

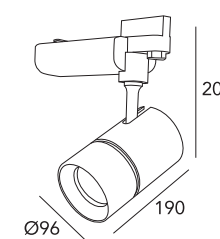

Description
 Surface mount Fully Adj. track spotlight
Lamp
 50W COB LED, 4500lm
Beam
 Adjustable beam 15°- 50°
Color
 3000K, 3500K, 4000K
Input Voltage
 220V
Size
 96mm DIA X 190mm(L)

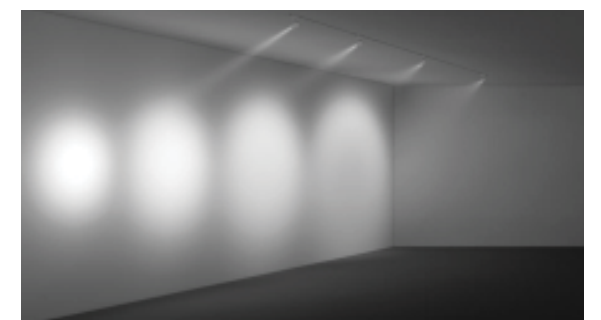
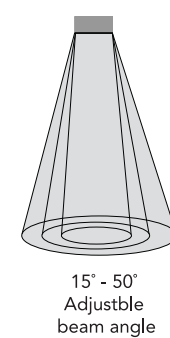



T-210/xx-COB-20W-xK

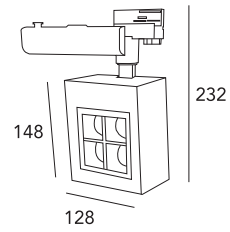

Description
Surface mount Fully Adj. track wall washer

Lamp
20W COB LED, 1800lm

Beam
Wide Flood

Color
2700K, 3000K, 4000K, 5000K

Input Voltage
38V 300mA

Size
128mm(W) X 148mm(L) X 232mm(H)



SURFACE TRACK

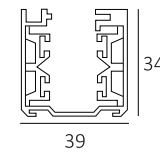
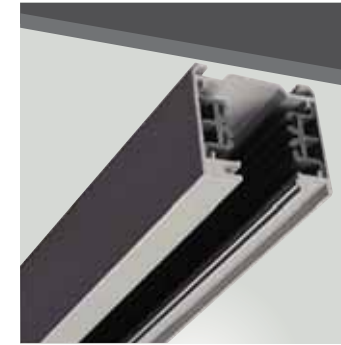

Length 1000mm, 1500mm, 2000mm



RECESSED TRACK

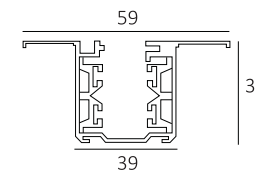
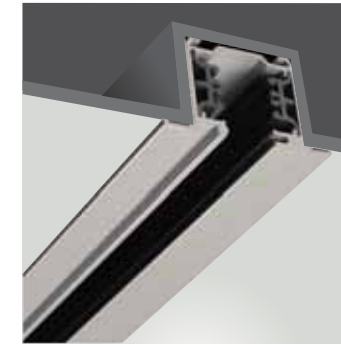

Length 1000mm, 1500mm, 2000mm

- When connecting to a three phase network each of the three circuit can be loaded to a maximum of 16A.
- Each red brass conductors are separately protected by isolation materials, to avoid the interfering from each order.
- The lamps mounted on each track shall not exceed its rated load.

1 - Circuit

For this type or connection, the 3-circuits on the entire track are controlled through one switch.

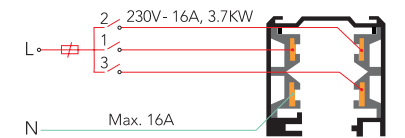

3 - Circuit

For this type of connection, each circuit is controlled through one switch.

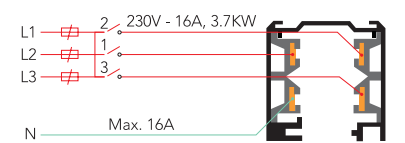

T-211/xx-COB-35W-xK

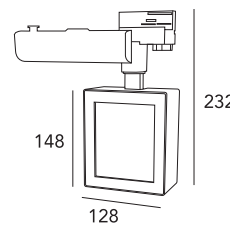

Description
Surface mount Fully Adj. track wall washer

Lamp
35W COB LED, 3150lm

Beam
Wide Flood

Color
2700K, 3000K, 4000K, 5000K

Input Voltage
38V 300mA

Size
128mm(W) X 148mm(L) X 232mm(H)



TT-001-1M-WH/BK

Description
surface mount 1circuit/ 3circuit track

Size
1.0m L

Note
with end feed

TT-001-1.5M-WH/BK

Description
surface mount 1circuit/ 3circuit track

Size
1.5m L

Note
with end feed

TT-001-2M-WH/BK

Description
surface mount 1circuit/ 3circuit track

Size
2.0m L

Note
with end feed



T-212/xx-COB-19W-xK

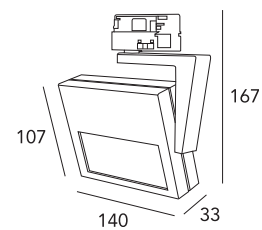

Description
Surface mount Fully Adj. track wall washer

Lamp
19W COB LED, 1800lm

Beam
Wide Flood

Color
2700K, 3000K, 4000K, 5000K

Input Voltage
500mA

Size
140mm(L) X 33mm(W) X 167mm(H)

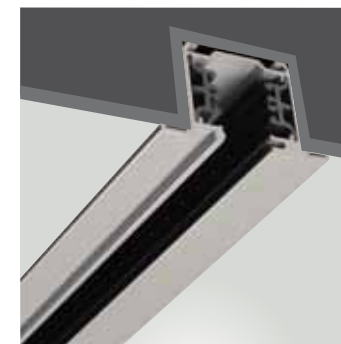

TT-002-1M-WH/BK

Description
Recessed 1circuit/ 3circuit track

Size
1.0m L

Note
with end feed

TT-002-1.5M-WH/BK

Description
Recessed 1circuit/ 3circuit track

Size
1.5m L

Note
with end feed

TT-002-2M-WH/BK

Description
Recessed 1circuit/ 3circuit track

Size
2.0m L

Note
with end feed



TT-001-EFeed-WH/BK

END FEED Connector surface
single circuit track

TT-002-EFeed-WH/BK

END FEED Connector surface
3 circuit track



TT-001-XFeed-WH/BK

X FEED Connector surface
single circuit track

TT-002-XFeed-WH/BK

X FEED Connector surface
3 circuit track



TT-001-EFeed-WH/BK

END FEED Connector surface
single circuit track

TT-002-EFeed-WH/BK

END FEED Connector surface
3 circuit track



TT-001-TFeed

T FEED Connector surface
single circuit track

TT-002-TFeed

T FEED Connector surface
3 circuit track



TT-001-Straight Feed-WH/BK

STRAIGHT FEED Connector surface
single circuit track

TT-002-Straight Feed-WH/BK

STRAIGHTFEED Connector surface
3 circuit track



TT-001-Flexible Feed-WH/BK

FLEXIBLE FEED Connector surface
single circuit track

TT-002-Elexible Feed-WH/BK

FLEXIBLE FEED Connector surface
3 circuit track



TT-001-IFeed-WH/BK

I FEED Connector surface
single circuit track

TT-002-IFeed-WH/BK

I FEED Connector surface
3 circuit track



TT-001-LFeed-WH/BK

L FEED Connector surface
single circuit track

TT-002-LFeed-WH/BK

L FEED Connector surface
3 circuit track

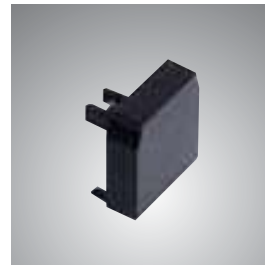

TT-001-Endcap-WH/BK

END CAP

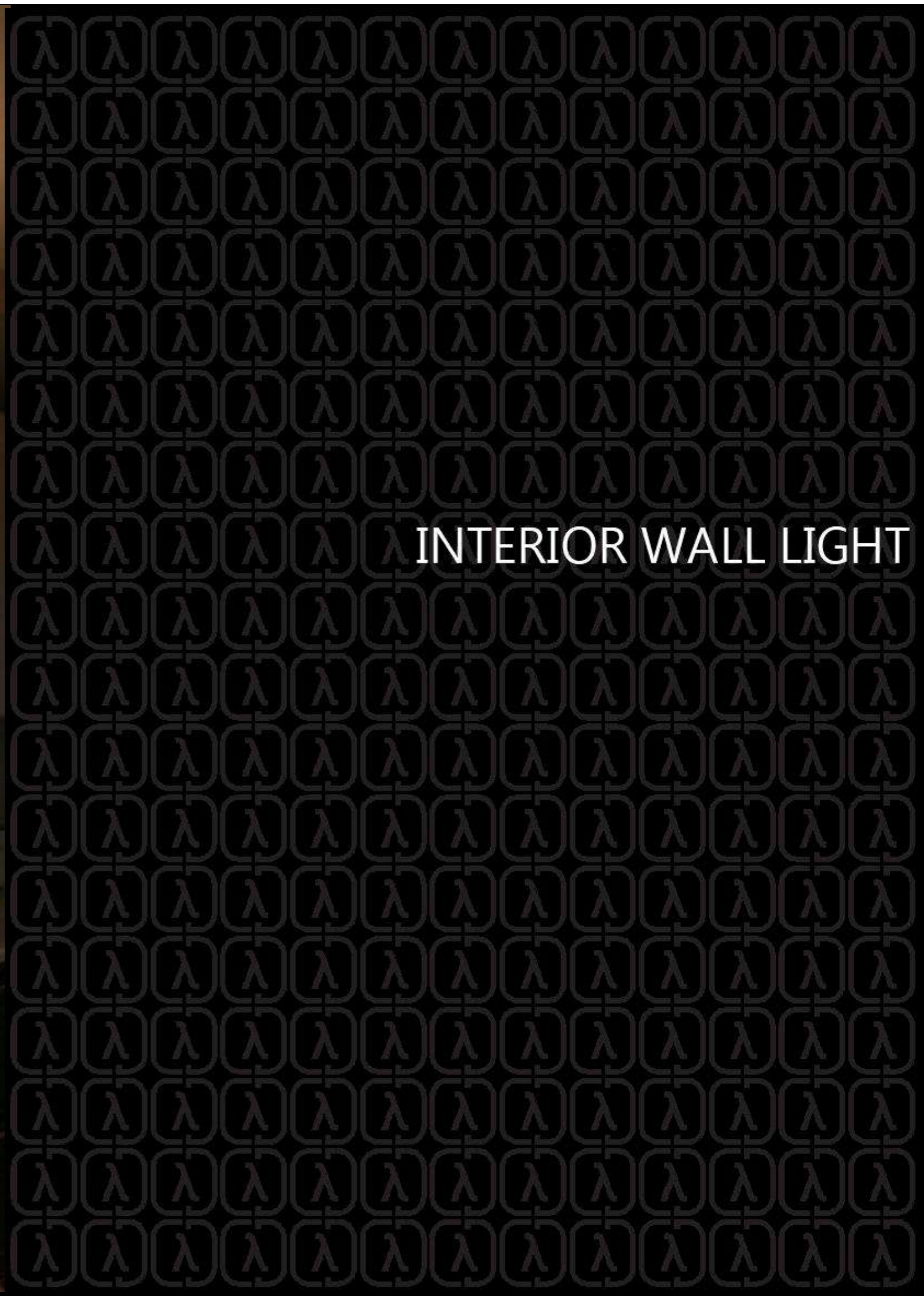

INTERIOR WALL LIGHT



R-W-201/xx-1W-xK

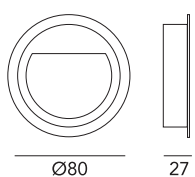

Description
Lamp Recessed LED Step light
1W, 3W SMD LED
Socket/ Input Voltage 220V
Color Warmwhite 3000K
Transformer Built-in LED Driver
Size 80mm DIA. X 27mm Recessed Depth
Wall cut out 69mm DIA.



R-W-204/xx-3W-xK

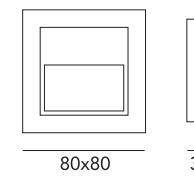

Description
Lamp Recessed LED Step light
1W SMD LED/ 3W SMD LED
Socket/ Input Voltage 230V
Color 2700K, 3000K, 4000K, 6000K
Red, Green, Blue
Transformer Built-in LED Driver
Size 80mm Square X 33mm Recessed Depth
Wall cut out 73mm X 70mm



R-W-202/xx-1W-xK

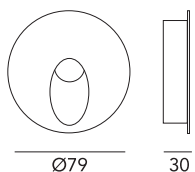

Description
Lamp Recessed LED Step light
1W, 3W SMD LED
Socket/ Input Voltage 12VDC
Beam /Color Warmwhite 3000K
Transformer Built-in LED Driver
Size 79mm DIA. X 30mm Recessed Depth
Wall cut out 65mm DIA.



R-W-205/xx-3W-xK

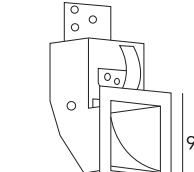

Description
Lamp Recessed LED Step light
1x1W LED, 1x3W LED
Socket/ Input Voltage 230V
Color 2700K, 3000K, 4000K, 6000K
Red, Green, Blue
Transformer Built-in LED Driver
Size 90mm Square X 61mm Recessed Depth
Wall cut out 73mm X 70mm



R-W-203/xx-1W-xK

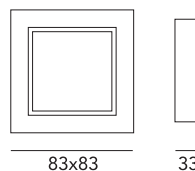

Description
Lamp Recessed LED Step light
1W SMD LED / 3W SMD LED
Socket/ Input Voltage 230V
Color 2700K, 3000K, 4000K, 6000K
Red, Green, Blue
Transformer Built-in LED Driver
Size 83mm Square X 33mm Recessed Depth
Wall cut out 73mm X 70mm



R-W-206/xx-6W-xK

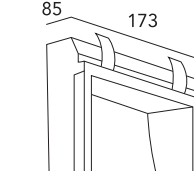

Description
Lamp Recessed LED Step light
2x1W LED, 2x3W LED
Socket/ Input Voltage 230V
Color 2700K, 3000K, 4000K, 6000K
Red, Green, Blue
Transformer Built-in LED Driver
Size 215mm(H) X173mm(W) 85mm Recessed Depth
Wall cut out 220mm X 180mm





R-W-207/xx-3W-xK

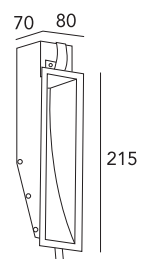

Description
 Recessed LED Step light
Lamp
 2x1W LED, 3W LED
Socket/ Input Voltage
 230V
Color
 2700K, 3000K, 4000K, 6000K
 Red, Green, Blue
Transformer
 Built-in LED Driver
Size
 215mm (H) X 80mm(W)
 70mm Recessed Depth
Wall cut out
 220mm X 70mm



S-W-201/xx-2x3W-xK

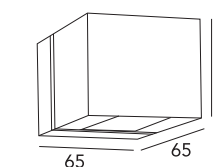

Description
 Surface mount Up-down
 LED Wall light
Lamp
 6W(2X3W) SMD LED
Socket/ Input Voltage
 220V
Beam /Color
 Warmwhite 3000K
Transformer
 Built-in LED Driver
Size
 65mm(W) X 65mm (L) X 72mm(H)



R-W-208/xx-3W-xK

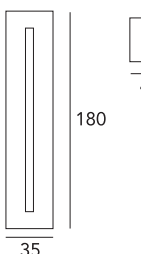

Description
 Recessed LED Step light
Lamp
 3W SMD LED
Socket/ Input Voltage
 12VDC
Beam /Color
 Warmwhite 3000K
Transformer
 Built-in LED Driver
Size
 35mm(W) X180mm(H)
 X 40mm Recessed depth
Wall Cutout
 25mm X 170mm



S-W-202/xx-3W-xK

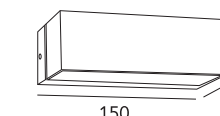

Description
 Surface mount LED Wall light
Lamp
 3W(1X3W) SMD LED
Socket/ Input Voltage
 220V
Beam /Color
 Warmwhite 3000K
Transformer
 Built-in LED Driver
Size
 150mm(W) X50mm (H) X 79mm(D)



S-W-201/xx-3W-xK

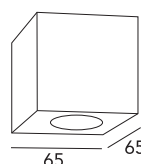

Description
 Surface mount LED Wall light
Lamp
 3W(1X3W) SMD LED
Socket/ Input Voltage
 220V
Beam /Color
 Warmwhite 3000K
Transformer
 Built-in LED Driver
Size
 65mm(W) X65mm (H) X 72mm(D)



S-W-202/xx-2x3W-xK

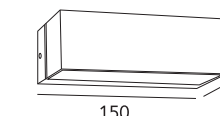

Description
 Surface mount LED
 Up-down wall light
Lamp
 6W(2X3W) SMD LED
Socket/ Input Voltage
 220V
Beam /Color
 Warmwhite 3000K
Transformer
 Built-in LED Driver
Size
 150mm(W) X50mm (H) X 79mm(D)





RL-301/xx
3W LED 170lm
3000K, 4000K, 6000K

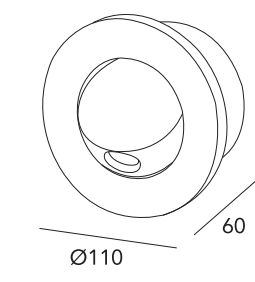

RL-302/xx
3W LED 170lm
3000K, 4000K, 6000K

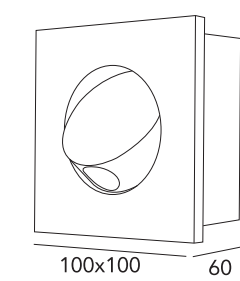



RL-303

LED 1W
Stainless Steel Polished
+Polished Chrome
IP20

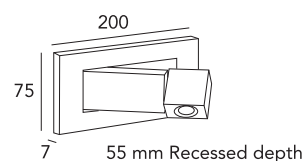

RL-304

LED 2x1W
Stainless Steel Polished
IP20

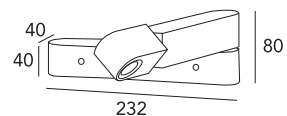

RL-307

LED 1W
Stainless Steel Polished
+Polished Chrome
IP20

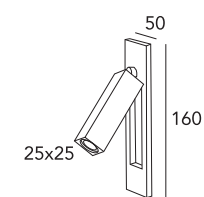

40 mm Recessed depth



RL-308

LED 1W
Stainless Steel Polished
+Polished Chrome
IP20

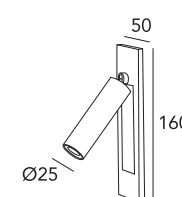

40 mm Recessed depth



RL-305

LED 3W
Stainless Steel Polished
+Polished Chrome
IP20

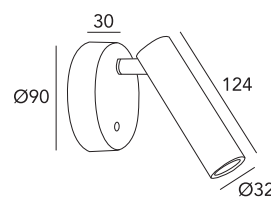

RL-306

LED 3W
Stainless Steel Polished
+Polished Chrome
IP20

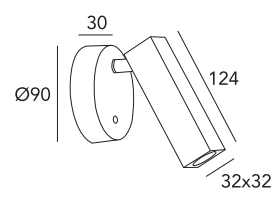

RL-309

LED 11W
Polished Chrome+
Stainless Steel Polished
IP20

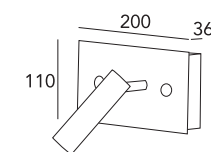

RL-310

LED 15.6W
Polished Chrome+
Stainless Steel Polished
IP20

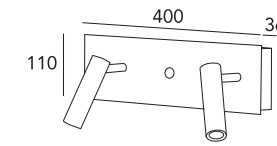



RL-311

LED 1x1W
Stainless Steel Polished
+Polished Chrome
IP20

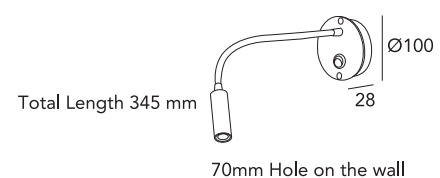

RL-312

LED 1x1W
Stainless Steel Polished
+Polished Chrome
IP20

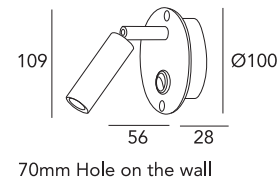

RL-313

LED 1x1W
Stainless Steel Polished
+Polished Chrome
IP20



RL-402

E27 1x40W+LED 1x1W
Stainless Steel Polished
+Polished Chrome

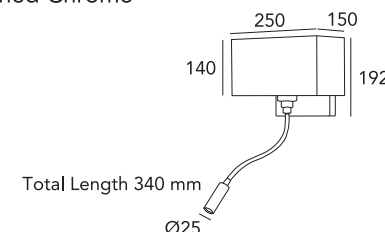

RL-403

E27 1x40W+LED 1x1W
Stainless Steel Polished
+Polished Chrome

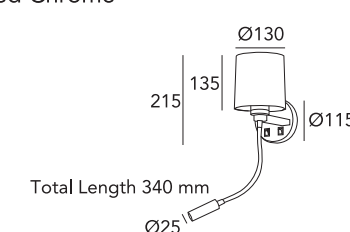

RL-404

E27 1x40W+LED 1x1W
Stainless Steel Polished
+Polished Chrome

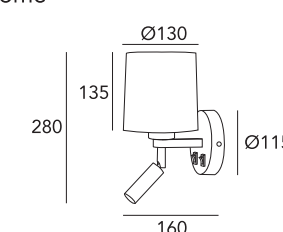

RL-314

LED 1x1W
Stainless Steel Polished
+Polished Chrome
IP20

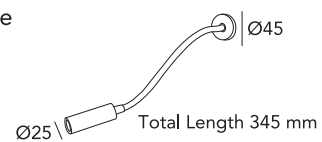

RL-401

E27 1x25W+LED 1x1W
Stainless Steel Polished
+Polished Chrome

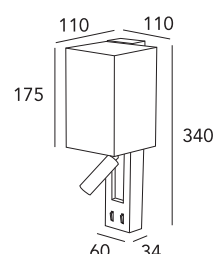

RL-405

E27 1x40W + 2x3W LED
-Polished Chrome+
Stainless Steel Polished
-Bronze

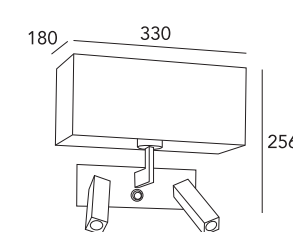

RL-406

E27 1x40W+LED 1x1W
Stainless Steel Polished
+Polished Chrome

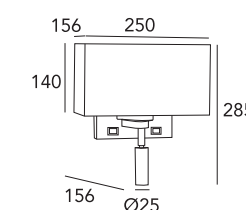



LED Vanity Light



VA-301
LED 1X10W
Stainless Steel Polished
+ Opal glass

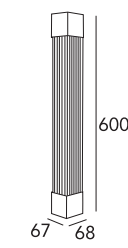

VA-302
LED 1X10W
Stainless Steel Polished
+ Opal glass

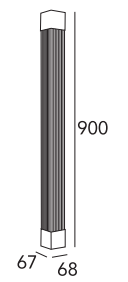

VA-303
LED 1X18W
Stainless Steel Polished
+ Opal glass

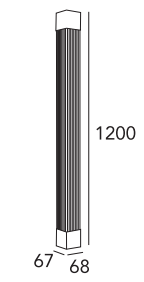

VA-304
LED 1X18W
Stainless Steel Polished
+ Opal glass

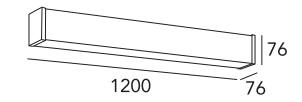



VA-305

LED 14W
Stainless Steel Polished
+ Opal glass
IP44

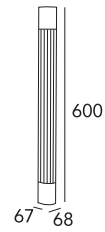

VA-306

LED 18W
Stainless Steel Polished
+ Opal glass
IP44

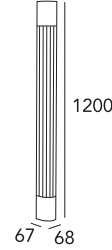

VA-308

LED 1X6W
Stainless Steel Polished
+Opal Glass

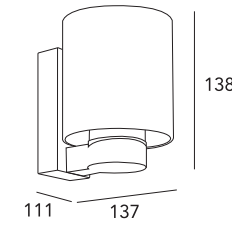

VA-309

LED 1X6W
Stainless Steel Polished
+Opal Glass

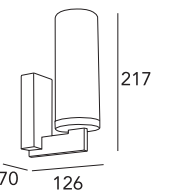

VA-307

LED 10W
Stainless Steel Polished
+ Opal glass
IP44

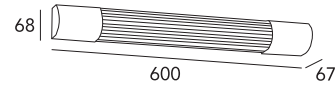

VA-310

LED 1x6W
Stainless Steel Polished
+ Opal Glass

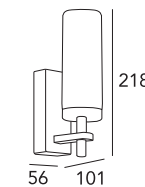

VA-311

LED 1x6W
Stainless Steel Polished
+ Opal Glass



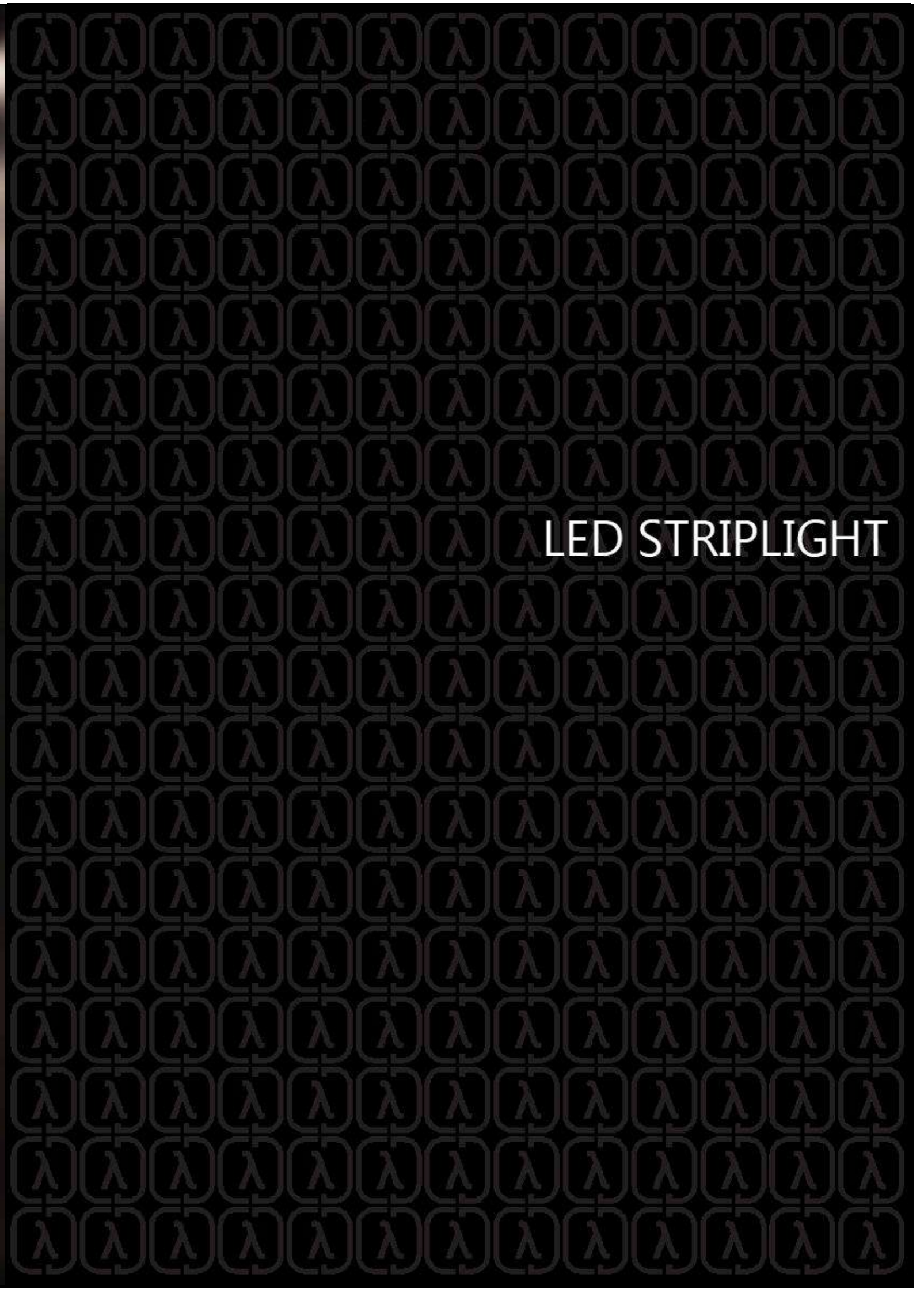

LED STRIPLIGHT

2700K



3000K



4000K



6000K



Tunable White



RGB Colour Changing



SLE-001-7W-24V-xK-IPxx

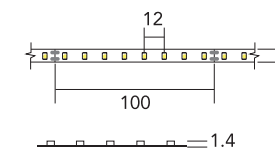

Description: LED strip light
 Lamp: SMD2835 LED
 Watt: 7.2W/m (60LEDs)
 970-1100LM, CRI80/90
 Input voltage: 24VDC
 Beam angle: 120D
 CCT: 2700K / 3000K / 4000K / 6000K
 Dimension: 8mm (W) X 1.4mm (H),
 LED pitch 12.5mm
 Cut length: 100mm
 IP rate: IP20/IP65/IP67/IP68
 Control options: TRIAC / 0-10V



SLE-001-10W-24V-xK-IPxx

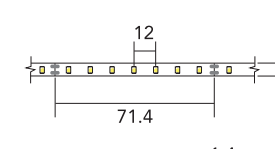

Description: LED strip light
 Lamp: SMD2835 LED
 Watt: 10W/m (98LEDs)
 1150-1400LM, CRI80/90
 Input voltage: 24VDC
 Beam angle: 120D
 CCT: 2700K / 3000K / 4000K / 6000K
 Dimension: 8mm (W) X 1.4mm (H)
 LED pitch 10.2mm
 Cut length: 71.4mm
 IP rate: IP20/IP65/IP67/IP68
 Control options: TRIAC / 0-10V



SLE-001-14W-24V-xK-IPxx

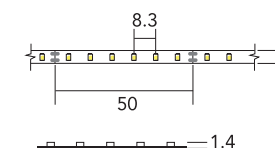

Description: LED strip light
 Lamp: SMD2835 LED
 Watt: 14.4W/m (120LEDs)
 1450-1670LM, CRI80/90
 Input voltage: 24VDC
 Beam angle: 120D
 CCT: 2700K / 3000K / 4000K / 6000K
 Dimension: 8mm (W) X 1.4mm (H)
 LED pitch 8.33mm
 Cut length: 50mm
 IP rate: IP20/IP65/IP67/IP68
 Control options: TRIAC / 0-10V

SLE-001-17W-24V-xK-IPxx

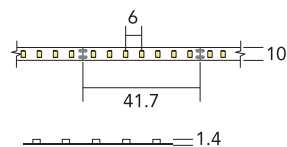

Description: LED strip light
 Lamp: SMD2835 LED
 Watt: 17.3W/m (168LEDs)
 2050-2340LM, CRI80/90
 Input voltage: 24VDC
 Beam angle: 120D
 CCT: 2700K / 3000K / 4000K / 6000K
 Dimension: 10mm (W) X 1.4mm (H)
 LED pitch 6mm
 Cut length: 41.7mm
 IP rate: IP20/IP65/IP67/IP68
 Control options: TRIAC / 0-10V

SLE-002-9W-24V-xK-IPxx

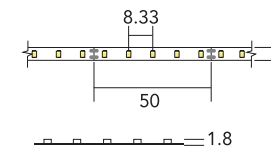

Description: LED strip light
 Lamp: SMD3528 LED
 Watt: 9.6W/m (120LEDs)
 790-880LM, CRI80/90
 Input voltage: 24VDC
 Beam angle: 120D
 CCT: 2700K / 3000K / 4000K / 6000K
 Dimension: 8mm (W) X 1.8mm (H)
 LED pitch 8.33mm
 Cut length: 50mm
 IP rate: IP20/IP65/IP67/IP68
 Control options: TRIAC / 0-10V

SLE-001-20W-24V-xK-IPxx

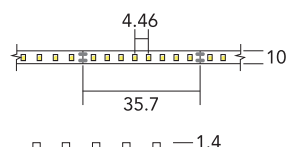

Description: LED strip light
 Lamp: SMD2835 LED
 Watt: 20.2W/m (224LEDs)
 2740-3120LM, CRI80/90
 Input voltage: 24VDC
 Beam angle: 120D
 CCT: 2700K / 3000K / 4000K / 6000K
 Dimension: 10mm (W) X 1.4mm (H)
 LED pitch 4.46mm
 Cut length: 35.7mm
 IP rate: IP20/IP65/IP67/IP68
 Control options: TRIAC / 0-10V

SLE-002-14W-24V-xK-IPxx

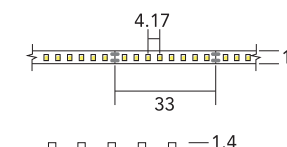

Description: LED strip light
 Lamp: SMD3528 LED
 Watt: 14.4W/m (240LEDs)
 1590-1760LM, CRI80/90
 Input voltage: 24VDC
 Beam angle: 120D
 CCT: 2700K / 3000K / 4000K / 6000K
 Dimension: 10mm (W) X 1.8mm (H)
 LED pitch 4.17mm
 Cut length: 33mm
 IP rate: IP20/IP65/IP67/IP68
 Control options: TRIAC / 0-10V

SLE-002-4W-24V-xK-IPxx

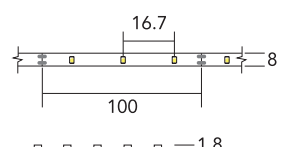

Description: LED strip light
 Lamp: SMD3528 LED
 Watt: 4.8W/m (60LEDs)
 390-450LM, CRI80/90
 Input voltage: 24VDC
 Beam angle: 120D
 CCT: 2700K / 3000K / 4000K / 6000K
 Dimension: 8mm (W) X 1.8mm (H)
 LED pitch 16.7mm
 Cut length: 100mm
 IP rate: IP20/IP65/IP67/IP68
 Control options: TRIAC / 0-10V



SLE-002-28W-24V-xK-IPxx

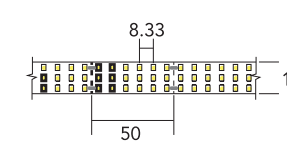

Description: LED strip light
 Lamp: SMD3528 LED
 Watt: 28.8W/m (360LEDs)
 2380-2635LM, CRI80/90
 Input voltage: 24VDC
 Beam angle: 120D
 CCT: 2700K / 3000K / 4000K / 6000K
 Dimension: 19mm (W) X 1.8mm (H)
 LED pitch 8.33mm
 Cut length: 50mm
 IP rate: IP20/IP65/IP67/IP68
 Control options: TRIAC / 0-10V

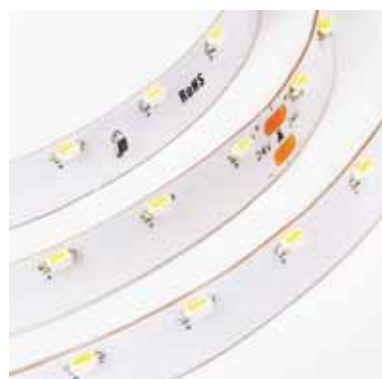

SLE-003-4W-24V-xK-IPxx

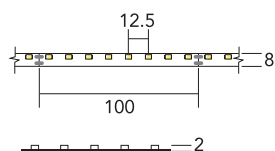

Description: LED side emitting strip light
Lamp: SMD3014 LED
Watt: 4.8W/m (80LEDs)
 600-700LM, CRI80/90
Input voltage: 24VDC
Beam angle: 120D
CCT: 2700K / 3000K / 4000K / 6000K
Dimension: 8mm (W) X 2mm (H)
 LED pitch 12.5mm
Cut length: 100mm
IP rate: IP20/IP65/IP67/IP68
Control options: TRIAC / 0-10V



SLE-004-14W-24V-xK-IPxx

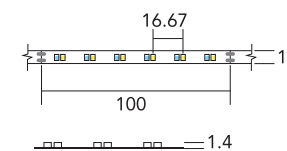

Description: LED tunable white strip light
Lamp: SMD2835 LED
Watt: 14.4W/m (120LEDs)
 1550LM MAX., CRI80/90
Input voltage: 24VDC
Beam angle: 120D
CCT: 2700K - 6000K
Dimension: 10mm (W) X 1.4mm (H)
 LED pitch 16.67mm
Cut length: 100mm
IP rate: IP20/IP65/IP67/IP68
Control options: PWM / RX / 0-10V



SLE-003-9W-24V-xK-IPxx

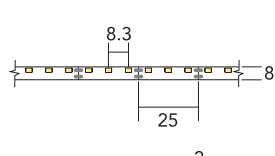

Description: LED side emitting strip light
Lamp: SMD3014 LED
Watt: 9.6W/m (120LEDs)
 950-1000LM, CRI80/90
Input voltage: 12VDC
Beam angle: 120D
CCT: 2700K / 3000K / 4000K / 6000K
Dimension: 8mm (W) X 2mm (H)
 LED pitch 8.33mm
Cut length: 25mm
IP rate: IP20/IP65/IP67/IP68
Control options: TRIAC / 0-10V



SLE-005-7W-24V-RGB-IPxx

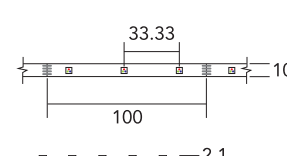

Description: LED RGB strip light
Lamp: SMD5050 LED
Watt: 7.2W/m (30LEDs): 260LM MAX
Input voltage: 12VDC
Beam angle: 120D
CCT: RED, GREEN, BLUE
Dimension: 10mm (W) X 2.1mm (H)
 LED pitch 33.33mm
Cut length: 100mm
IP rate: IP20/IP65/IP67/IP68
Control options: DMX control



SLE-004-8W-24V-xK-IPxx

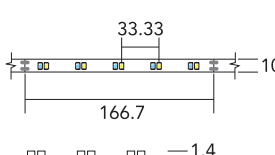

Description: LED tunable white strip light
Lamp: SMD2835 LED
Watt: 8.6W/m (60LEDs)
 800LM MAX., CRI80/90
Input voltage: 24VDC
Beam angle: 120D
CCT: 2700K - 6000K
Dimension: 10mm (W) X 1.4mm (H)
 LED pitch 33.33mm
Cut length: 166.7mm
IP rate: IP20/IP65/IP67/IP68
Control options: PWM/ RX / 0-10V



SLE-005-14W-24V-RGB-IPxx

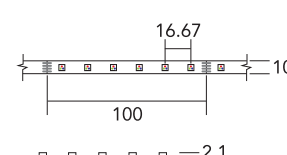

Description: LED RGB strip light
Lamp: SMD5050 LED
Watt: 14.4W/m (60LEDs): 520LM MAX
Input voltage: 24VDC
Beam angle: 120D
CCT: RED, GREEN, BLUE
Dimension: 10mm (W) X 2.1mm (H)
 LED pitch 16.67mm
Cut length: 100mm
IP rate: IP20/IP65/IP67/IP68
Control options: DMX control





SLE-005-17W-24V-RGB-IPxx

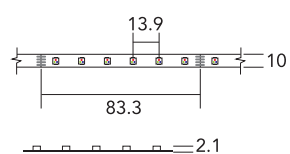

Description: LED RGB strip light
Lamp: SMD5050 LED
Watt: 17.2W/m (72LEDs): 620LM Max
Input voltage: 24VDC
Beam angle: 120D
CCT: RED, GREEN, BLUE
Dimension: 10mm (W) X 2mm (H)
 LED pitch 13.9vmm
Cut length: 83.3mm
IP rate: IP20/IP65/IP67/IP68
Control options: DMX control



SLE-006-9W-24V-RGBW-IPxx

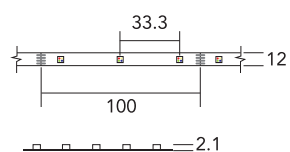

Description: LED RGBW strip light
Lamp: SMD5050 LED
Watt: 9.6W/m (30LEDs): 55-195LM MAX
Input voltage: 12VDC
Beam angle: 120D
CCT: RED, GREEN, BLUE
 WHITE (2400K, 2700K, 3000K)
Dimension: 12mm (W) X 2.1mm (H)
 LED pitch 33.3mm
Cut length: 100mm
IP rate: IP20/IP65/IP67/IP68
Control options: DMX control



SLE-006-19W-24V-RGBW-IPxx

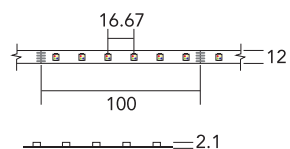

Description: LED RGBW strip light
Lamp: SMD5050 LED
Watt: 19.2W/m (72LEDs): 155-390LM MAX
Input voltage: 24VDC
Beam angle: 120D
CCT: RED, GREEN, BLUE
 WHITE (2400K, 2700K, 3000K)
Dimension: 12mm (W) X 2.1mm (H)
 LED pitch 16.67mm
Cut length: 100mm
IP rate: IP20/IP65/IP67/IP68
Control options: DMX control



C - Clear



F - Frosted



O - Opal



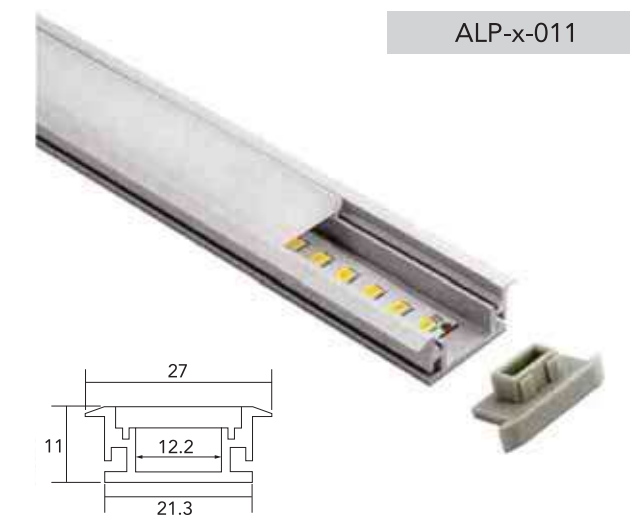
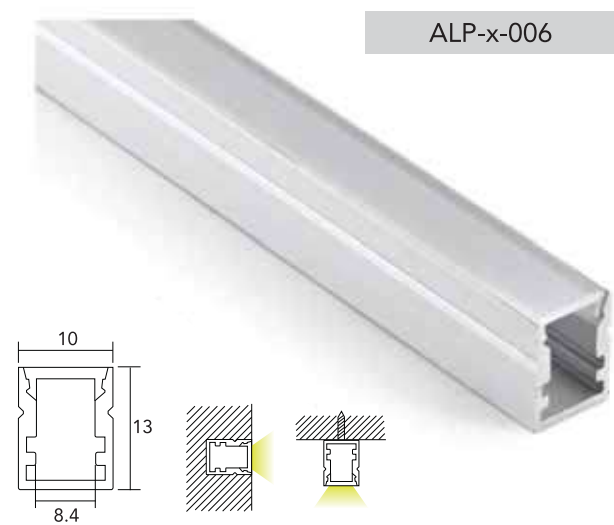
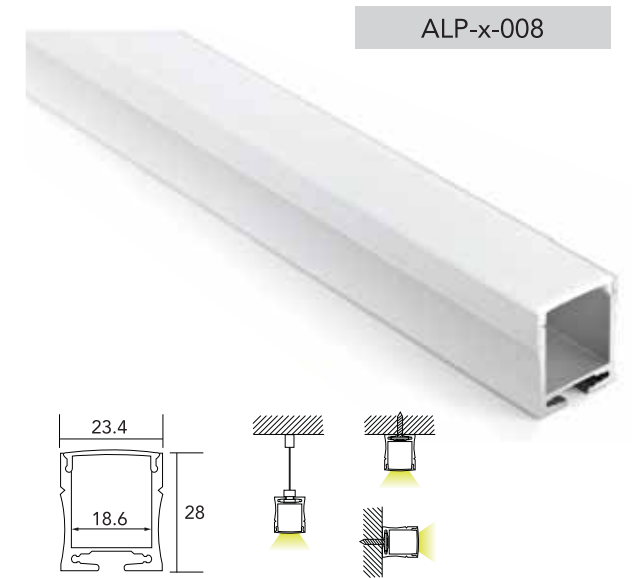

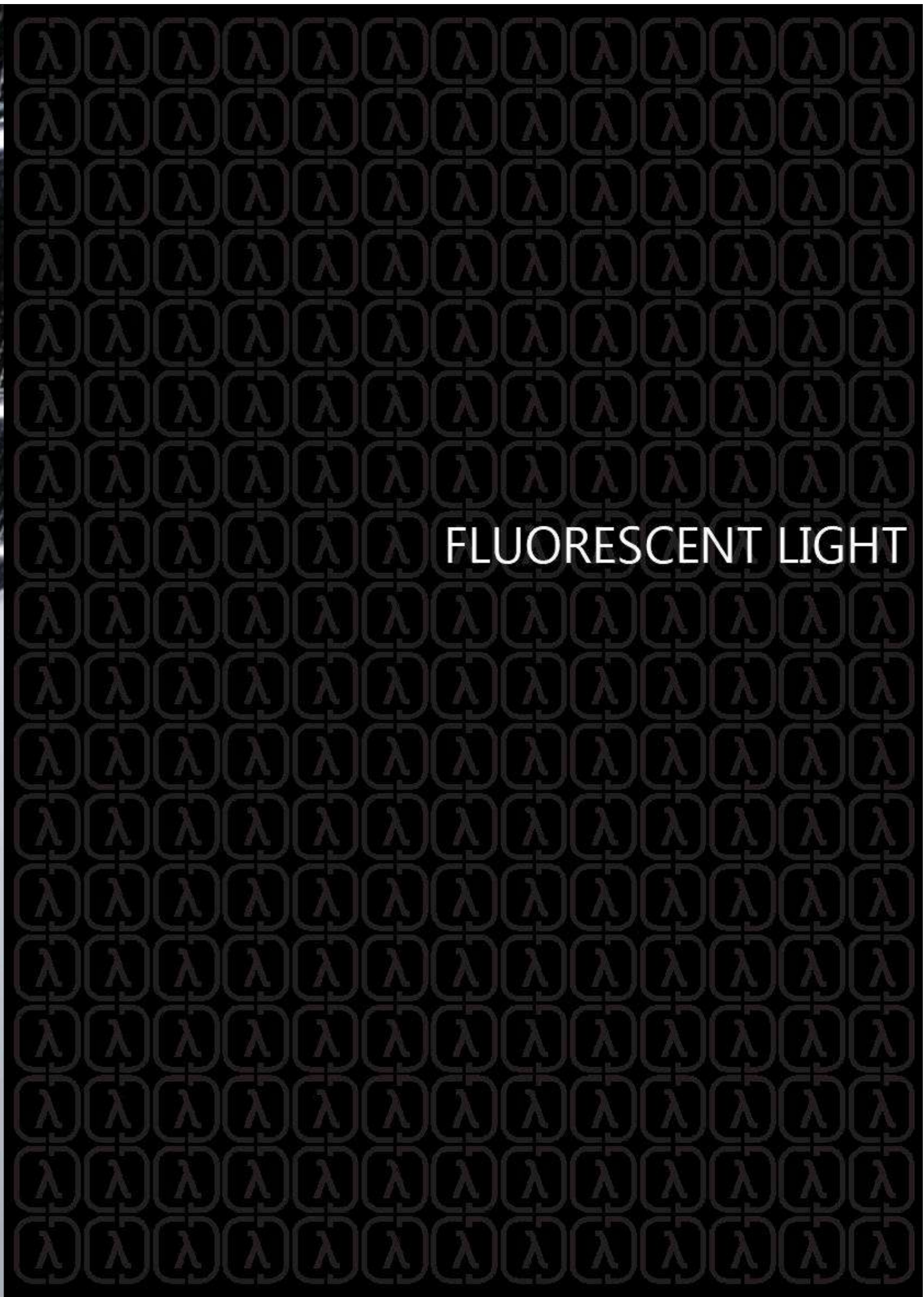
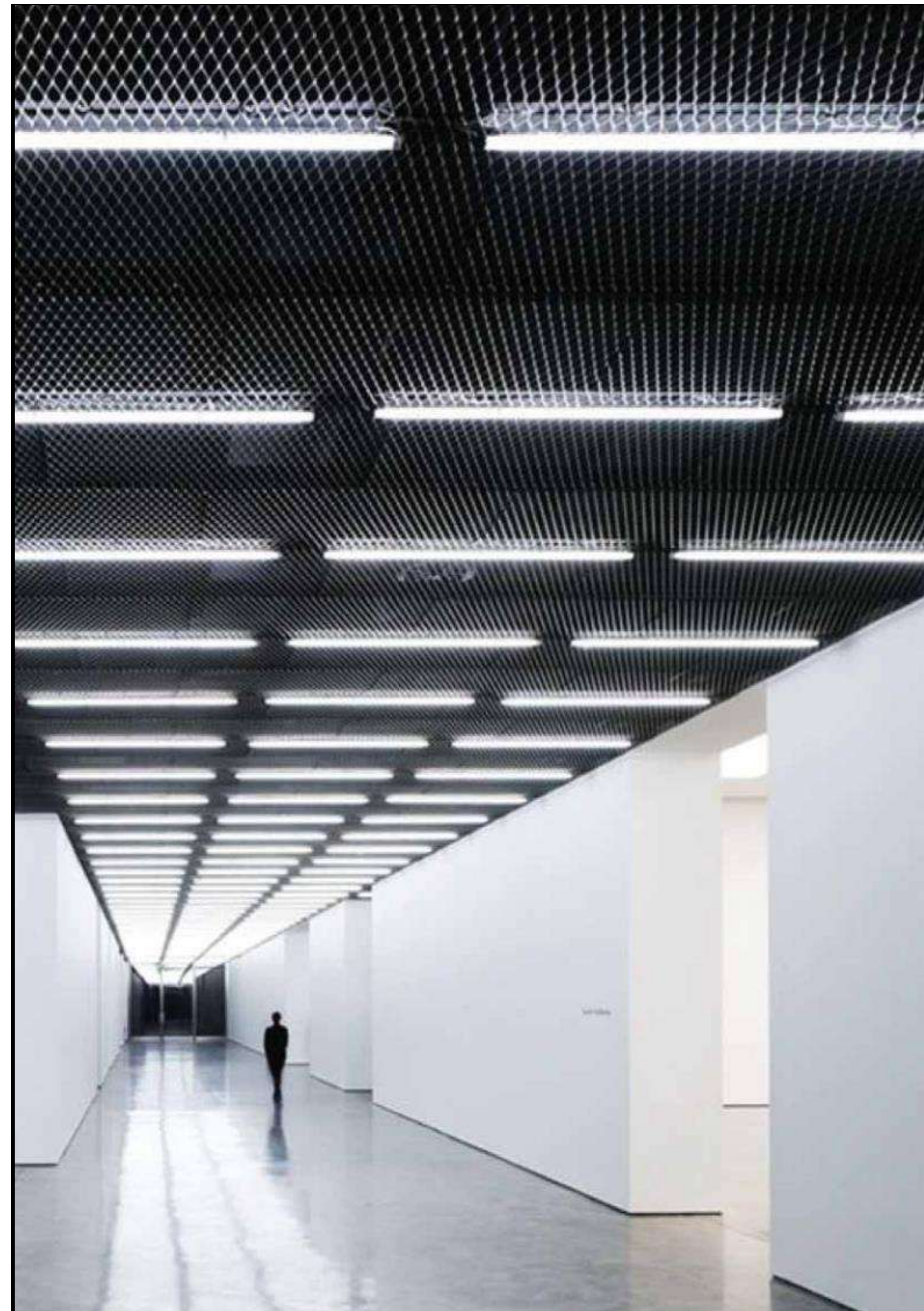

FLUORESCENT LIGHT

Acrylic Pendant

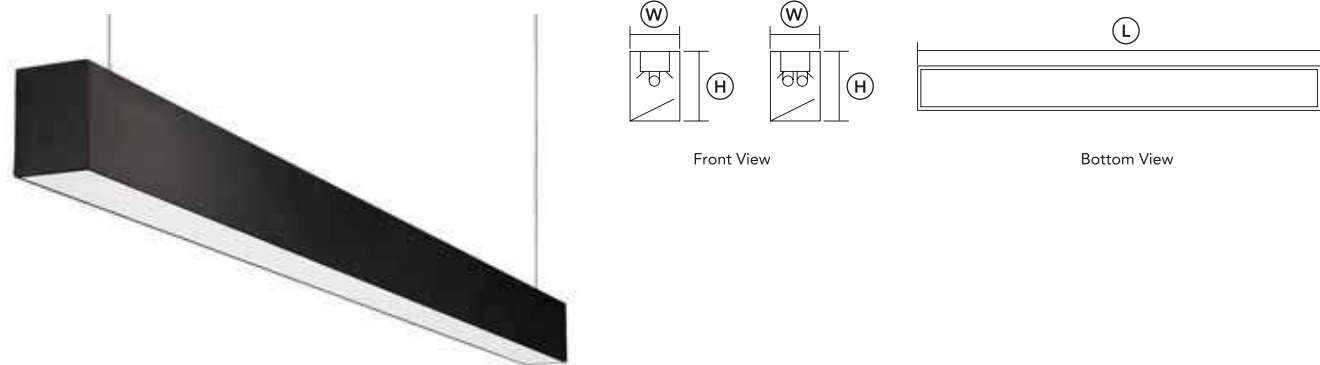

Specification		W	L	H	
Catalogue No.	Lamp	W x L x H (mm.)		Socket	
FL-001/xx-T5-128	1x T5 28W	85	1245	120	G5
FL-001/xx-T5-228	2x T5 28W	85	1245	120	G5
FL-001/xx-T8-136	1x T8 36W	85	1245	120	G13
FL-001/xx-T8-236	2x T8 36W	85	1245	120	G13

Housing : Steel
 Reflector : Mirror aluminum
 Diffuser : Acrylic
 Colour : white/ Black/ Grey

Double Acrylic Pendant

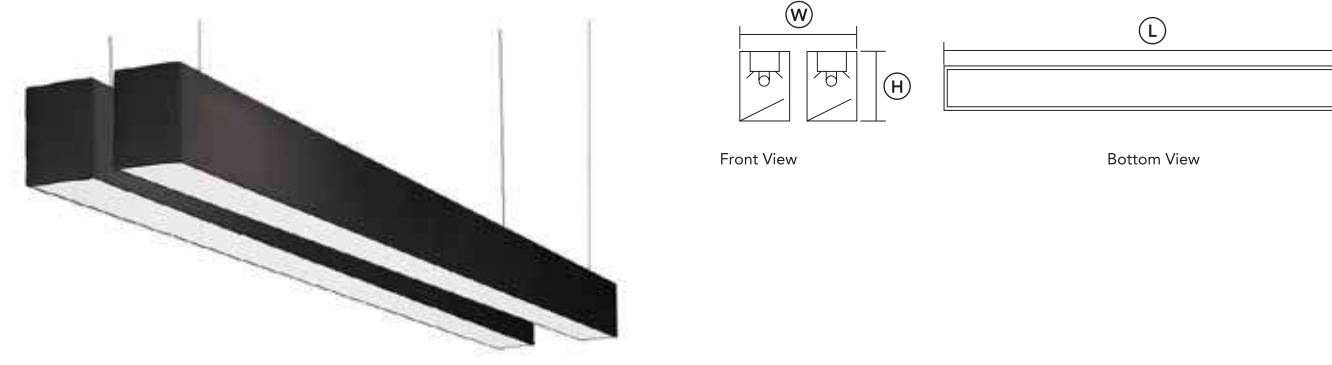

Specification		W	L	H	
Catalogue No.	Lamp	W x L x H (mm.)		Socket	
FL-003/xx-T5-228	2x T5 28W	220	1245	120	G5
FL-003/xx-T5-428	4x T5 28W	220	1245	120	G5
FL-003/xx-T8-236	2x T8 36W	220	1245	120	G13
FL-003/xx-T8-436	4x T8 36W	220	1245	120	G13

Housing : Steel
 Reflector : Mirror aluminum
 Diffuser : Acrylic
 Colour : white/ Black/ Grey

Direct - Indirect Pendant

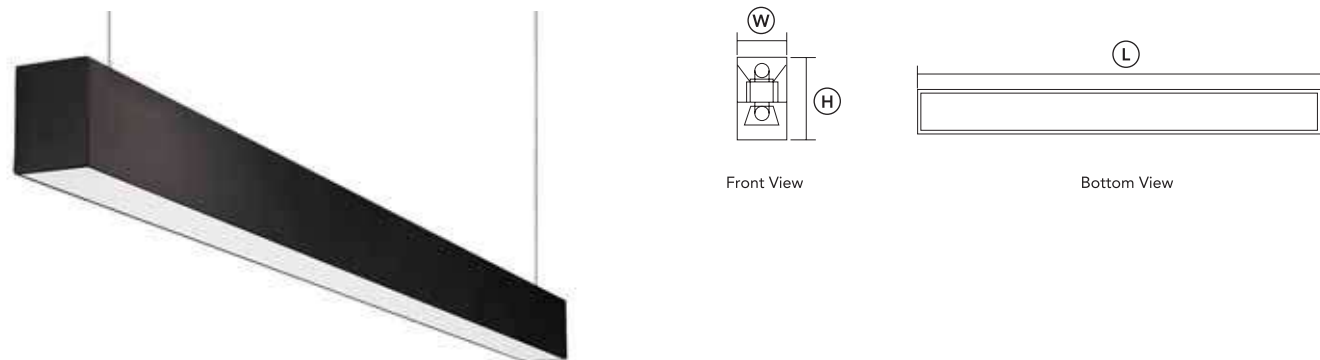

Specification		W	L	H	
Catalogue No.	Lamp	W x L x H (mm.)		Socket	
FL-002/xx-T5-214	2x T5 14W	60	600	95	G5
FL-002/xx-T5-228	2x T5 28W	60	1200	95	G5

Housing : Steel
 Reflector : Mirror aluminum
 Diffuser : Acrylic
 Colour : white/ Black/ Grey

RECESSED ACRYLIC LUMINAIRE

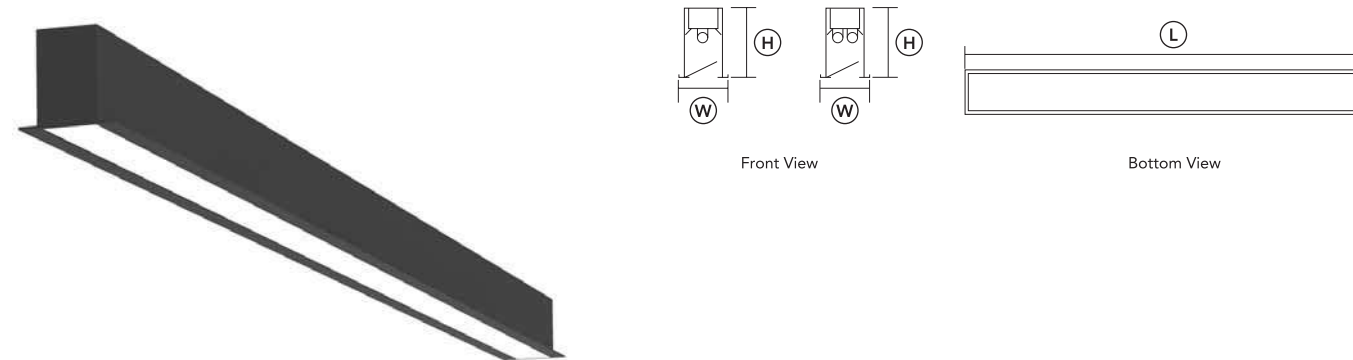

Specification		W	L	H	
Catalogue No.	Lamp	W x L x H (mm.)		Socket	
FL-004/xx-T5-128	1x T5 28W	100	1190	120	G5
FL-004/xx-T5-128	2x T5 28W	100	1190	120	G5
Catalogue No.	1x T8 36W	100	1190	120	G13
Catalogue No.	2x T8 36W	100	1190	120	G13

Housing : Steel
 Reflector : Mirror aluminum
 Diffuser : Acrylic
 Colour : white/ Black/ Grey

RECESSED OPAL TYPE

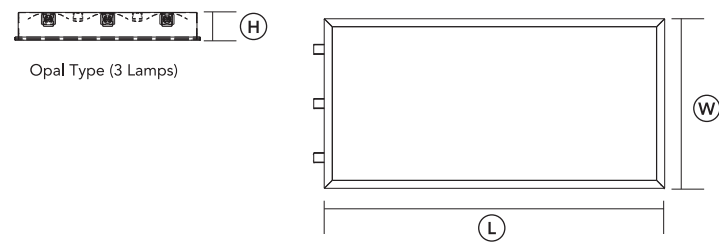

Specification		W	L	H	
Catalogue No.	Lamp	W x L x H (mm.)		Socket	
FL-005/30120-T5-128	1x T5 28W	300	1200	90	G5
FL-005/30120-T5-228	2x T5 18W	300	1200	90	G5
FL-005/6060-T5-214	2x T5 14W	600	600	90	G5
FL-005/60120-T5-228	2x T5 28W	600	1200	90	G5
FL-005/6060-T5-314	3x T5 14W	600	600	90	G5
FL-005/60120-T5-328	3x T5 28W	600	1200	90	G5
FL-005/30120-T8-136	1x T8 36W	300	1200	90	G13
FL-005/30120-T8-218	2x T8 18W	300	1200	90	G13
FL-005/30120-T8-236	2x T8 36W	300	1200	90	G13
FL-005/60120-T8-218	2x T8 18W	600	1200	90	G13
FL-005/60120-T8-236	2x T8 36W	600	1200	90	G13
FL-005/60120-T8-318	3x T8 18W	600	1200	90	G13
FL-005/60120-T8-336	3x T8 36W	600	1200	90	G13

Housing : Steel
 Reflector : Anodized Aluminum
 Diffuser : Opal Acrylic
 Colour : White / Black

RECESSED LOUVER FITTING

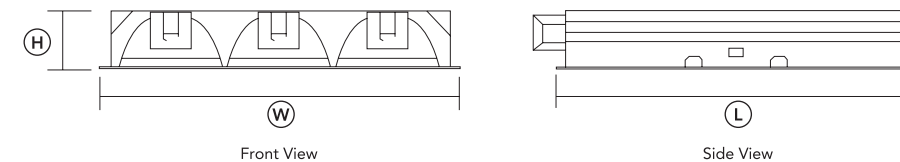

Specification		W	L	H	
Catalogue No.	Lamp	W x L x H (mm.)		Socket	
FL-007/6060-T5-214	2x T5 14W	595	595	85	G5
FL-007/6060-T5-314	3x T5 14W	595	595	85	G5
FL-007/30120-T5-228	2x T5 28W	295	1195	85	G5
FL-007/60120-T5-228	2x T5 28W	595	1195	85	G5
FL-007/60120-T5-328	3x T5 28W	595	1195	85	G5
FL-007/6060-T8-218	2x T8 18W	595	595	85	G13
FL-007/6060-T8-318	3x T8 18W	595	595	85	G13
FL-007/30120-T8-236	2x T8 36W	295	1195	85	G13
FL-007/60120-T8-236	2x T8 36W	595	1195	85	G13
FL-007/60120-T8-336	3x T8 36W	595	1195	85	G13

Housing : Steel
 Reflector : Mirror aluminum louver
 Colour : Satin off-white

SURFACE OPAL TYPE

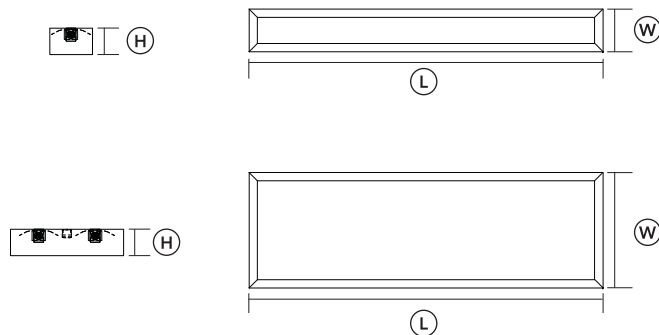

Specification		W	L	H	
Catalogue No.	Lamp	W x L x H (mm.)		Socket	
FL-006/8120-T5-128	1x T5 28W	80	1220	85	G5
FL-006/18120-T5-228	2x T5 28W	180	1220	82	G5

Housing : Steel
 Reflector : Anodized Aluminum
 Diffuser : Opal Acrylic
 Colour : White / Black

SURFACE LOUVER FITTING

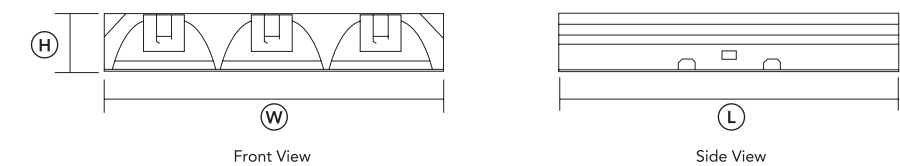

Specification		W	L	H	
Catalogue No.	Lamp	W x L x H (mm.)		Socket	
FL-008/30120-T5-128	1x T5 28W	300	1200	60	G5
FL-008/30120-T5-228	2x T5 28W	300	1200	60	G5
FL-008/6060-T5-214	2x T5 14W	600	600	60	G5
FL-008/60120-T5-228	2x T5 28W	600	1200	60	G5
FL-008/6060-T5-314	3x T5 14W	600	600	60	G5
FL-008/60120-T5-328	3x T5 28W	600	1200	60	G5
FL-008/30120-T8-136	1x T8 36W	300	1220	60	G13
FL-008/30120-T8-236	2x T8 36W	300	1220	60	G13
FL-008/60120-T8-218	2x T8 18W	600	1220	60	G13
FL-008/60120-T8-236	2x T8 36W	600	1220	60	G13
FL-008/60120-T8-318	3x T8 18W	600	1220	60	G13
FL-008/60120-T8-336	3x T8 36W	600	1220	60	G13

Housing : Steel
 Reflector : Matted aluminum
 Colour : Satin off-white

Fluorescent High bay

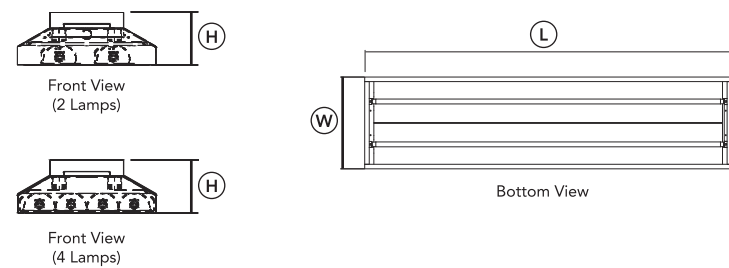

Specification		W	L	H	
Catalogue No.	Lamp	W x L x H (mm.)		Socket	
FL-009/30120-T5-228	2x T5 28W	300	1200	85	G5
FL-008/30120-T5-428	4x T5 28W	300	1200	135	G5

Housing : Steel
 Reflector : Mirror aluminum
 Colour : Satin off-white

CURVE-1

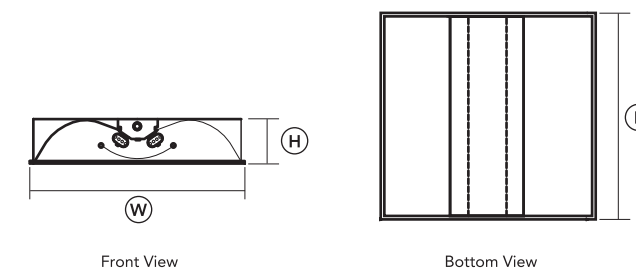

Specification		W	L	H	
Catalogue No.	Lamp	W x L x H (mm.)		Socket	
FL-111/6060-T5-214	2x T5 14W	595	595	125	G5
FL-111/6060-T5-314	3x T5 14W	595	595	125	G5
FL-111/60120-T5-228	2x T5 28W	595	1198	125	G5
FL-111/60120-T5-328	3x T5 28W	595	1198	125	G5
FL-111/6060-T8-218	2x T8 18W	595	595	125	G13
FL-111/6060-T8-236	3x T8 18W	595	595	125	G13
FL-111/60120-T8-318	2x T8 36W	595	1198	125	G13
FL-111/60120-T8-336	3x T8 36W	595	1198	125	G13

Housing : Steel
 Diffuser : PMMA
 Colour : Satin off-white

U-SHAPE

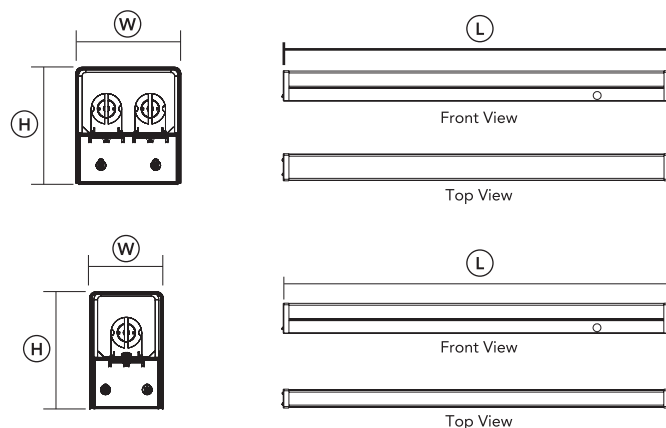

Specification		W	L	H	
Catalogue No.	Lamp	W x L x H (mm.)		Socket	
FL-110/660-T5-114	1x T5 14W	60	600	95	G5
FL-110/6120-T5-128	1x T5 28W	60	1200	95	G5
FL-110/860-T5-214	2x T5 14W	85	600	95	G5
FL-110/8120-T5-228	2x T5 28W	85	1200	95	G5
FL-110/660-T8-118	1x T8 18W	60	610	95	G13
FL-110/6120-T8-136	1x T8 36W	60	1220	95	G13
FL-110/860-T8-218	2x T8 18W	85	610	95	G13
FL-110/8120-T8-236	2x T8 36W	85	1220	95	G13

Housing : Steel
 Diffuser : PMMA/ Milky Acrylic
 Colour : Satin off-white

CURVE-2

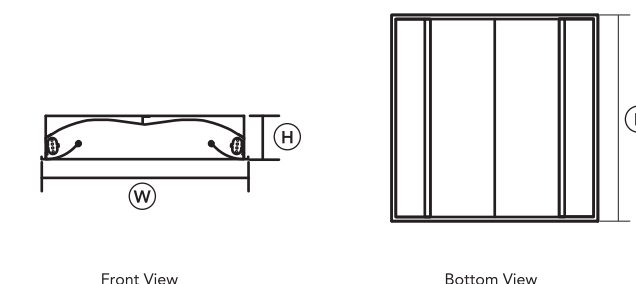

Specification		W	L	H	
Catalogue No.	Lamp	W x L x H (mm.)		Socket	
FL-112/6060-T5-214	2x T5 14W	595	595	125	G5
FL-112/60120-T5-228	2x T5 28W	595	1198	125	G5
FL-112/6060-T5-218	2x T8 18W	595	595	125	G13
FL-112/60120-T8-236	2x T8 36W	595	1198	125	G13

Housing : Steel
 Diffuser : PMMA
 Colour : Satin off-white

CURVE-3

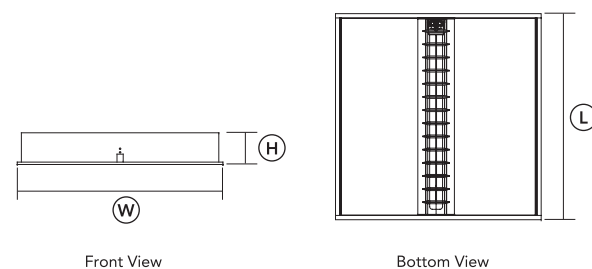

Specification		W	L	H
Catalogue No.	Lamp	W x L x H (mm.)		Socket
FL-113/6060-T5-114	1x T5 14W	598 x 598 x 92		G5
FL-113/6060-T5-214	2x T5 14W	598 x 598 x 92		G5
FL-113/6060-T8-118	1x T8 18W	598 x 598 x 92		G13
FL-113/6060-T8-218	2x T8 18W	598 x 598 x 92		G13

Housing : Steel
 Reflector : Mirror aluminum louver
 Diffuser : PMMA
 Colour : Satin off-white

CURVE-V

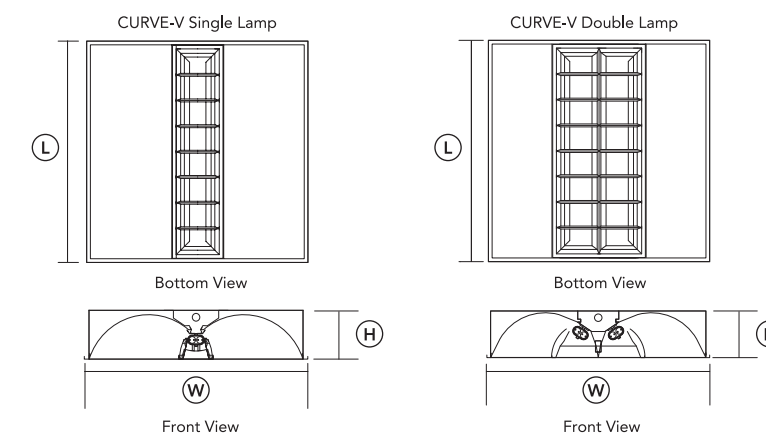

Specification		W	L	H
Catalogue No.	Lamp	W x L x H (mm.)		Socket
FL-115/6060-T5-214	2x T5 14W	596 x 598 x 125		G5
FL-115/60120-T5-228	2x T5 28W	596 x 1198 x 125		G5
FL-115/6060-T8-218	2x T8 18W	596 x 598 x 125		G13
FL-115/60120-T8-236	2x T8 36W	596 x 1198 x 125		G13

Housing : Steel
 Reflector : Mirror aluminum louver
 Diffuser : PMMA
 Colour : Satin off-white

CURVE HOSPITAL

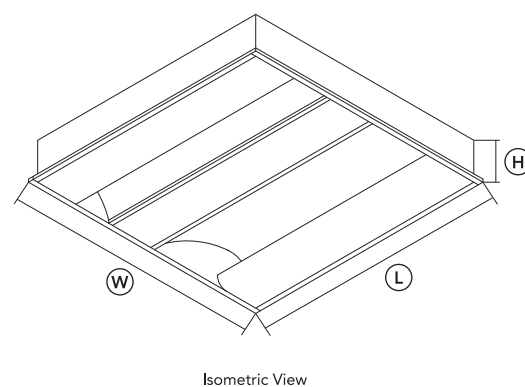

Specification		W	L	H
Catalogue No.	Lamp	W x L x H (mm.)		Socket
FL-114/6060-T5-114	2x T5 14W	595 x 595 x 96		G5
FL-114/6060-T8-118	2x T8 18W	595 x 595 x 96		G13

Housing : Steel
 Diffuser : PMMA
 Colour : Satin off-white

CURVE-W

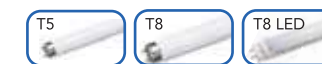
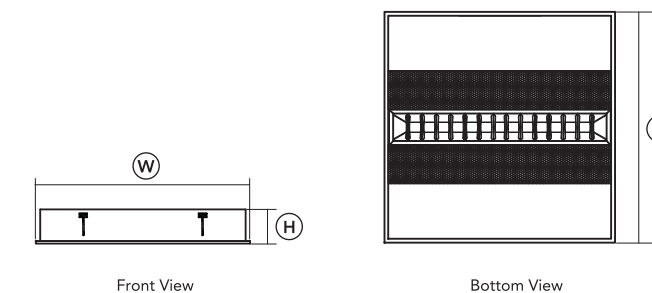

Specification		W	L	H
Catalogue No.	Lamp	W x L x H (mm.)		Socket
FL-115/6060-T5-314	3x T5 14W	595 x 595 x 95		G5
FL-115/6060-T8-318	3x T8 18W	595 x 595 x 95		G13

Housing : Steel
 Reflector : Perforated steel
 Louvre : Mirror aluminum louver
 Colour : Satin off-white

VECTRA

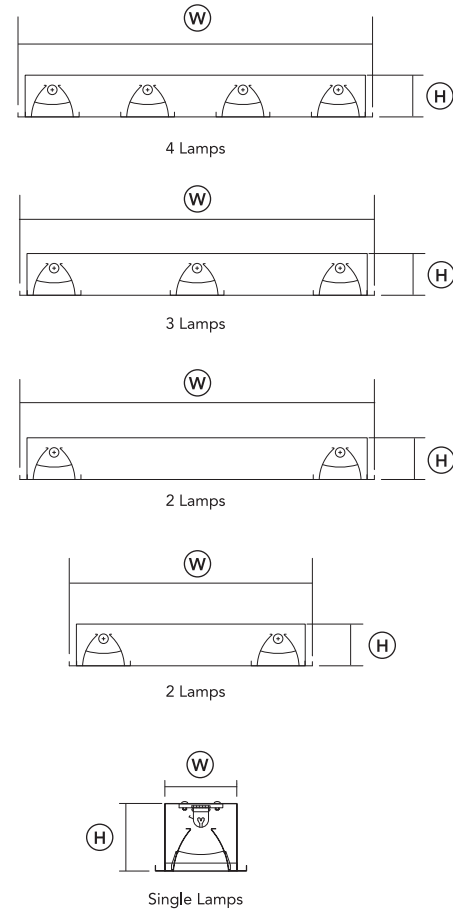

Specification		W	L	H
Catalogue No.	Lamp	W x L x H (mm.)		Socket
FL-117/6060-T5-214	2x T5 14W	595	595	60
FL-117/6060-T5-314	3x T5 14W	595	595	60
FL-117/6060-T5-414	4x T5 14W	595	595	60
FL-117/30120-T5-228	2x T5 28W	295	1198	60
FL-117/60120-T5-228	2x T5 28W	595	1198	60
FL-117/60120-T5-328	3x T5 28W	595	1198	60
FL-117/60120-T5-428	4x T5 28W	595	1198	60
FL-117/6060-T8-218	2x T8 28W	595	595	60
FL-117/6060-T8-318	3x T8 18W	595	595	60
FL-117/6060-T8-418	4x T8 18W	595	595	60
FL-117/30120-T8-236	2x T8 36W	295	1198	60
FL-117/60120-T8-236	2x T8 36W	595	1198	60
FL-117/60120-T8-336	3x T8 36W	595	1198	60
FL-117/60120-T8-436	4x T8 36W	595	1198	60

Housing : Steel
 Reflector : Mirror aluminum louver
 Diffuser : PMMA
 Colour : Satin off-white

VIEW

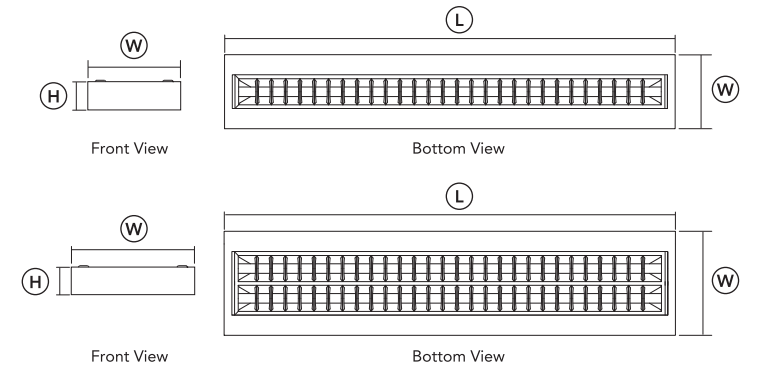

Specification		W	L	H
Catalogue No.	Lamp	W x L x H (mm.)		Socket
FL-118/2060-T5-114	1x T5 14W	200	620	60
FL-118/20120-T5-128	1x T5 28W	200	1230	60
FL-118/3060-T5-214	2x T5 14W	282	620	60
FL-118/30120-T5-228	2x T5 28W	282	1230	60
FL-118/2060-T8-118	1x T8 18W	200	620	60
FL-118/20120-T8-136	1x T8 36W	200	1230	60
FL-118/30120-T8-218	2x T8 18W	282	620	60
FL-118/30120-T8-236	2x T8 36W	282	1230	60

Housing : Steel
 Reflector : Mirror aluminum louver
 Colour : Satin off-white

INDUSTRIAL

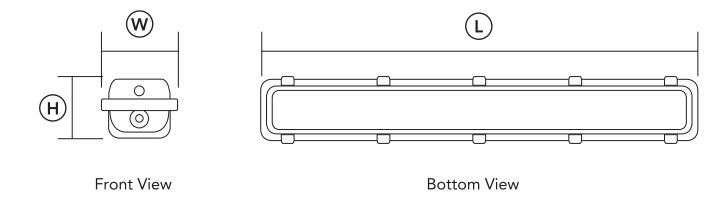

Specification		W	L	H
Catalogue No.	Lamp	W x L x H (mm.)		Socket
FL-119/2060-T5-114	1x T5 14W	110	680	110
FL-119/20120-T5-128	2x T5 14W	160	680	110
FL-119/3060-T5-214	1x T5 28W	110	1286	110
FL-119/30120-T5-228	2x T5 28W	160	1286	110
FL-119/2060-T8-118	1x T8 18W	110	680	110
FL-119/20120-T8-218	2x T8 18W	160	680	110
FL-119/30120-T8-136	1x T8 36W	110	1286	110
FL-119/30120-T8-236	2x T8 36W	160	1286	110

Housing : Steel
 Reflector : Matted aluminum louvre
 Diffuser : Acrylic
 Colour : Satin off-white

LAMBDA
DYNAMIC

Lambda Dynamic Co.,Ltd
27/57 Soi Athon Upratham, Phacharath Sai 1 Road,
Bangsue , Bangkok 10800

TEL : +6691-010-9191
Email : lambda.dynamic@gmail.com

2025-2026
INTERIOR LIGHTING CATALOGUE